



VINEX CANOPY

Easy up canopy made of aluminium frame and heavy duty polyester fabric. Easy to fold & store. **Size :** 3 m x 3 m

- VCAN-3X3M** Without bag
- VCAN-3X3MWB** With bag

Customised sizes are also available on request.



VINEX CANOPY - SUPER

Easy up canopy made of aluminium frame and heavy duty polyester fabric. Easy to fold & store. **Size :** 2 m x 2 m

- VCAN-2X2M** Without bag
- VCAN-2X2MWB** With bag

Customised sizes are also available on request.

VINEX TEAM SHELTER SUPER

8 seater, Heavy Duty mobile team shelter made of steel equipped with plastic moulded seats. High quality transparent polycarbonate roof. Seat height 45 cm from ground level.

Shelter size : 2.0m (L) x 1.01m (D) x 1.75m (H)

VTSH-S100



VINEX TEAM SHELTER - CLASSIC

Made of Aluminium sheet and rectangular tubes. Shelter made of transparent Polycarbonate sheet and sitting bench made of wood.

Shelter size : 4.80m (L) x 0.80m (D) x 2.25m (H)

Seating Size : 4.80m (L) x 0.46m (D) x 0.52m (H)

VTSH-CL100

* It can also be customized as per requirement. Please ask for more details.





AWARDS AND CERTIFICATES

BHALLA INTERNATIONAL is the First Indian Sporting Goods Company to get SA 8000:2008 Certificate and 100% Export Oriented Unit accreditation from Govt. of India



SA 8000:2008



100+ World Athletics Certified Athletic Equipment



BS EN 748:2013 Soccer Goal Post



FITB Approved Tchoukball Frame



IABF Approved Boxing Ring



Awarded #1 for Exports of Athletic Equipment

- REACH** 1900+ REACH Certified Products
- CE EN 71** 1250+ CE EN 71 Certified Products
- CPSIA** 950+ CPSIA Certified Products
- TTFI** Table Tennis Approved by TTFI
- AFI** Official Supplier to Athletics Federation of India

Awarded No. 1 by SGEPC for Highest Exports of Athletic Equipment from India





INTERNATIONAL
RECOGNITION

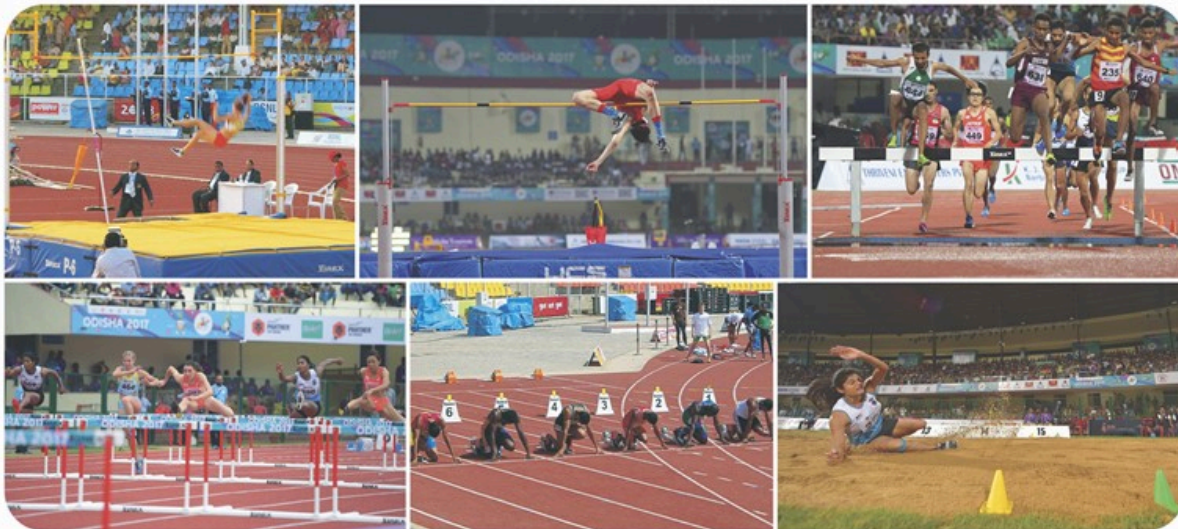



 <p>IAAF Certified Equipment List Pg# 4 - 12</p>	 <p>Cross Bar Pg# 44</p>
 <p>Discus Pg# 13 - 18</p>	 <p>High Jump Pit / Standards Pg# 45 - 47</p>
 <p>Shot Pg# 19 - 20</p>	 <p>Pole Vault Pit / Standards Pg# 48 - 50</p>
 <p>Indoor Shot Pg# 21</p>	 <p>Kidz Athletics Pg# 51 - 54</p>
 <p>Hammer Pg# 22</p>	 <p>Track Kerbing Pg# 55</p>
<h1>C O N T E N T S</h1>	
 <p>Starting Block Pg# 23 - 28</p>	 <p>Throwing Cage Pg# 56 - 58</p>
 <p>Relay Baton Pg# 28</p>	 <p>Track & Field Equipment / Accessories Pg# 59 - 67</p>
 <p>Hurdle Pg# 29 - 40</p>	 <p>Field Carts / Sports Facility Equipment Pg# 68 - 72</p>
 <p>Javelin / Javelin Training Pg# 41 - 43</p>	<div style="background-color: red; color: white; padding: 5px; display: inline-block;">TEST INFORMATION</div> <p>Pg# 73</p>

Awarded No. 1 by SGEPC
for Highest Exports of Athletic Equipment from India





VINEX CARBON DISCUS - PRO

VCD-P20	2.00 kg	IAAF CERTIFICATE # I-16-0784
VCD-P10	1.00 kg	IAAF CERTIFICATE # I-16-0783



Page # 13



VINEX HYPER SPIN DISCUS

VHS-200	2.00 kg	IAAF CERTIFICATE # I-02-0286
VHS-100	1.00 kg	IAAF CERTIFICATE # I-02-0285



Page # 13



VINEX GOLD - 100 WOCF

DGP-B20	2.00 kg	IAAF CERTIFICATE # I-09-0426
DGP-B10	1.00 kg	IAAF CERTIFICATE # I-09-0425



Page # 13



VINEX SUPER SPIN ALLOY STEEL

DAP-200	2.00 kg	IAAF CERTIFICATE # I-06-0366
DAP-100	1.00 kg	IAAF CERTIFICATE # I-06-0363



Page # 14



VINEX HIGH SPIN DISCUS

DSR-P20	2.00 kg	IAAF CERTIFICATE # I-01-0253
DSR-P17	1.75 kg	IAAF CERTIFICATE # I-04-0313
DSR-P15	1.50 kg	IAAF CERTIFICATE # I-04-0314
DSR-P10	1.00 kg	IAAF CERTIFICATE # I-99-0149



Page # 14



VINEX LO SPIN DISCUS

DSB-P20	2.00 kg	IAAF CERTIFICATE # I-06-0365
DSB-P17	1.75 kg	IAAF CERTIFICATE # I-06-0364
DSB-P15	1.50 kg	IAAF CERTIFICATE # I-06-0378
DSB-P10	1.00 kg	IAAF CERTIFICATE # I-06-0362



Page # 15





VINEX PRACTICE DISCUS

DSG-P20	2.00 kg	IAAF CERTIFICATE # I-06-0377
DSG-P17	1.75 kg	IAAF CERTIFICATE # I-14-0726
DSG-P10	1.00 kg	IAAF CERTIFICATE # I-06-0376



Page # 15



VINEX SUPER CHALLENGE DISCUS

DSC-P10	IAAF CERTIFICATE # I-15-0742
DSC-P15	IAAF CERTIFICATE # I-15-0743
DSC-P20	IAAF CERTIFICATE # I-15-0744



Page # 15



VINEX SELECT PRACTICE WOMEN - WOCP

DWP-7010	IAAF CERTIFICATE # I-17-0819
----------	------------------------------



Page # 16



VINEX SELECT LOW SPIN WOMEN - WOCP

DWP-7510	IAAF CERTIFICATE # I-17-0823
----------	------------------------------



Page # 16



VINEX SELECT LOW SPIN MEN - WOCP

DWP-7517	IAAF CERTIFICATE # I-17-0824
DWP-7520	IAAF CERTIFICATE # I-17-0825



Page # 16



VINEX SELECT HIGH SPIN WOMEN - WOCP

DWP-8010	IAAF CERTIFICATE # I-17-0820
----------	------------------------------



Page # 16





VINEX SELECT HIGH SPIN MEN - WOCP

DWP-8017 IAAF CERTIFICATE # I-17-0821
 DWP-8020 IAAF CERTIFICATE # I-17-0822



Page # 17



VINEX SUPER CHALLENGE SHOTPUT

VST-500 IAAF CERTIFICATE # I-15-0740
 VST-600 IAAF CERTIFICATE # I-15-0741



Page # 19



VINEX SHOT SUPER - 200

VSP-295	4.00 kg	95 mm	IAAF CERTIFICATE # I-99-0179
VSP-209	4.00 kg	109 mm	IAAF CERTIFICATE # I-06-0361
VSP-229	7.26 kg	129 mm	IAAF CERTIFICATE # I-02-0287



Page # 19



VINEX TURNED IRON SHOT SUPER

VSP-325	7.26 kg	125 mm	IAAF CERTIFICATE # I-01-0252
VSP-320	7.26 kg	120 mm	IAAF CERTIFICATE # I-99-0180
VSP-325B	6.00 kg	125 mm	IAAF CERTIFICATE # I-08-0416
VSP-320B	6.00 kg	120 mm	IAAF CERTIFICATE # I-04-0312
VSP-315A	5.00 kg	115 mm	IAAF CERTIFICATE # I-04-0310
VSP-303	4.00 kg	103 mm	IAAF CERTIFICATE # I-04-0311
VSP-300C	3.00 kg	108 mm	IAAF CERTIFICATE # I-12-0574



Page # 19



VINEX TURNED ECONOMY IRON HAMMER

HVI-300C	3.00 kg	88 mm	IAAF CERTIFICATE # I-12-0575
HVI-500	5.00 kg	115 mm	IAAF CERTIFICATE # I-06-0371
HVI-600	6.00 kg	115 mm	IAAF CERTIFICATE # I-06-0372
HVI-400	4.00 kg	102 mm	IAAF CERTIFICATE # I-14-0672
HVI-726	7.26 kg	120 mm	IAAF CERTIFICATE # I-14-0674



Page # 22





VINEX SUPER CHALLENGE HAMMER

HVT-500 IAAF CERTIFICATE # I-15-0745
 HVT-600 IAAF CERTIFICATE # I-15-0746
 HVT-726 IAAF CERTIFICATE # I-15-0747



Page # 22



VINEX SUPER - 200

HVS-F40	4.00 kg	95 mm	IAAF CERTIFICATE # I-99-0178
HVS-726	7.26 kg	110 mm	IAAF CERTIFICATE # I-01-0251
HVS-500	5.00 kg	100 mm	IAAF CERTIFICATE # I-14-0680
HVS-600	6.00 kg	107 mm	IAAF CERTIFICATE # I-14-0673



Page # 22



VINEX HAMMER HANDLES

HHV-102 IAAF CERTIFICATE # I-01-0251



Page # 22

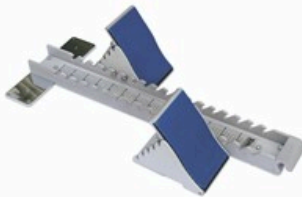

VINEX PRO FX

VSF-111 IAAF CERTIFICATE # E-15-0841



Page # 23

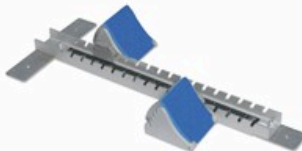

VINEX OLYMPIC MARK-I

VSF-01B IAAF CERTIFICATE # E-02-0340



Page # 23



VINEX NEW OLYMPIC MARK-I

VSF-01N IAAF CERTIFICATE # E-06-0452



Page # 23

Awarded No. 1 by SGEPC
 for Highest Exports of Athletic Equipment from India





VINEX RELAY BATON ALUMINIUM GOLD - 100

RBA-S06 IAAF CERTIFICATE # E-99-0190

VINEX RELAY BATON PLASTIC SUPER - 200

RBP-S06 IAAF CERTIFICATE # E-99-0154



Page # 28



VINEX AUTOMATIC HURDLE - PRO

VSH-1000 IAAF CERTIFICATE # E-20-1052



Page # 29



VINEX HURDLE PRO ALUMINIUM

VSH-A222 IAAF CERTIFICATE # E-17-0915



Page # 29



VINEX OLYMPIC - AUTOMATIC HURDLE

VSH-666 IAAF CERTIFICATE # E-10-0606



Page # 30



VINEX HURDLE - VELOCITY

VSH-101 IAAF CERTIFICATE # E-06-0446



Page # 30



VINEX PRO - HURDLE

VSH-222FX IAAF CERTIFICATE # E-02-0341
VSH-222HG IAAF CERTIFICATE # E-02-0341



Page # 31





STEEPLECHASE BARRIERS

SCB-100 IAAF CERTIFICATE # E-07-0502
 SCB-100EPDM IAAF CERTIFICATE # E-17-0924



Page # 39



VINEX WATER BARRIERS

VTWB-100 IAAF CERTIFICATE # E-10-0589
 VTWB-100EPDM IAAF CERTIFICATE # E-17-0925



Page # 39

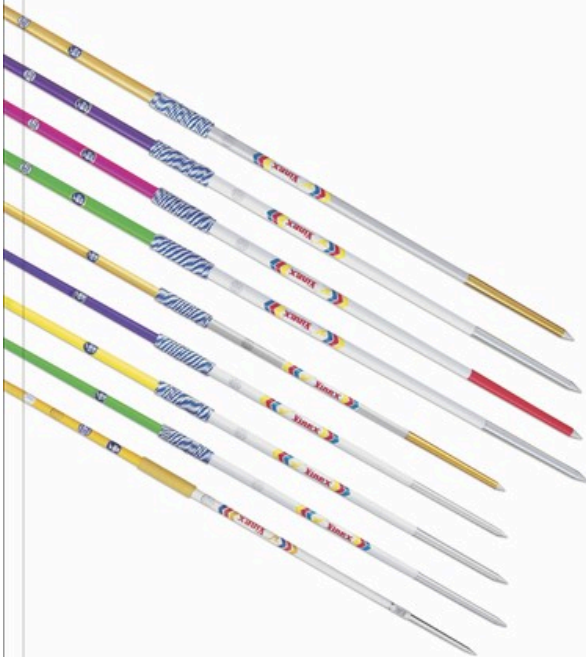

VINEX COMPETITION JAVELINS

800 gm JAVELINS

	Weight	Range	
JAL-80090	800 gm	90 m	IAAF CERTIFICATE # I-09-0440
JAL-80080	800 gm	80 m	IAAF CERTIFICATE # I-09-0439
JAL-80070	800 gm	70 m	IAAF CERTIFICATE # I-09-0438
JAL-80060	800 gm	60 m	IAAF CERTIFICATE # I-09-0437

700 gm JAVELINS

	Weight	Range	
JAL-70080	700 gm	80 m	IAAF CERTIFICATE # I-12-0621
JAL-70070	700 gm	70 m	IAAF CERTIFICATE # I-12-0620

600 gm JAVELINS

	Weight	Range	
JAL-60080	600 gm	80 m	IAAF CERTIFICATE # I-09-0436
JAL-60070	600 gm	70 m	IAAF CERTIFICATE # I-09-0435
JAL-60060	600 gm	60 m	IAAF CERTIFICATE # I-09-0434
JAL-60050	600 gm	50 m	IAAF CERTIFICATE # I-09-0433

500 gm JAVELINS

	Weight	Range	
JAL-50040	500 gm	40 m	IAAF CERTIFICATE # I-12-0576



Page # 41



VINEX SUPER CHALLENGE JAVELIN

JAL-CH600 IAAF CERTIFICATE # I-15-0748
 JAL-CH700 IAAF CERTIFICATE # I-15-0749
 JAL-CH800 IAAF CERTIFICATE # I-15-0750



Page # 42

Awarded No. 1 by SGEPC
 for Highest Exports of Athletic Equipment from India





FIBREGLASS CROSSBAR

VFG-C4 4.0 m IAAF CERTIFICATE # E-04-0382
 VFG-C45 4.5 m IAAF CERTIFICATE # E-06-0434



Page # 44



HIGH JUMP VINEX LANDING AREA / PIT INTERNATIONAL

VHJP-700 IAAF CERTIFICATE # E-05-0414



Page # 45



HIGH JUMP STAND OLYMPIC

HJS-A11 IAAF CERTIFICATE # E-07-0503



Page # 46



HIGH JUMP STAND - SUPREME

HJS-S01 IAAF CERTIFICATE # E-06-0447



Page # 46



HIGH JUMP STAND - COMPETITION

HJS-XXX IAAF CERTIFICATE # E-04-0381



Page # 47



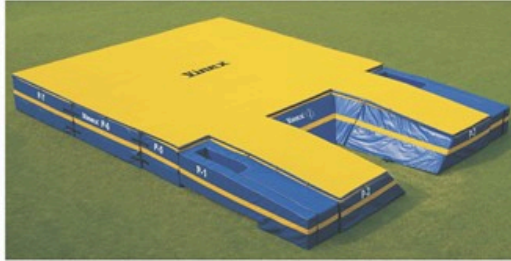

POLE VAULT PIT COMPETITION

VPVP-700 (600 cm x 800 cm x 80 cm)
IAAF CERTIFICATE # E-05-0413



Page # 48-49



POLE VAULT STAND - COMPETITION

PVS-CPTA IAAF CERTIFICATE # E-06-0453



Page # 50



VINEX TRACK KERBING

VTK-100 IAAF CERTIFICATE # E-07-0504



Page # 55



VINEX DISCUS AND HAMMER THROWING CAGE

DHC-S101 IAAF CERTIFICATE # E-09-0569



Page # 56





VINEX POLE VAULT BOX - COMPETITION
PVT-SS1 IAAF CERTIFICATE # E-08-0541



Page # 61

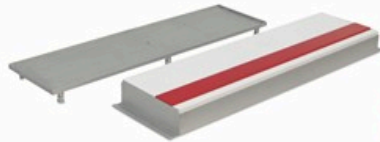

VINEX TAKE - OFF BOARD SYSTEM
WHITE BOARD WITH TRAY & BLANKING BOARD
VSTB-100 IAAF CERTIFICATE # E-09-0549
RED PLASTICINE BOARD
VSTB-P100 IAAF CERTIFICATE # E-09-0550



Page # 61



VINEX FIBRE STOP BOARD - COMPETITION
STB-F100 IAAF CERTIFICATE # E-08-0544



Page # 61



SHOT TOE BOARD ALUMINIUM
STB-A/100 IAAF CERTIFICATE # E-05-0415



Page # 62



VINEX SHOT / HAMMER THROWING CIRCLE - ALUMINIUM
DSHC-SPA10 IAAF CERTIFICATE # E-08-0542



Page # 63



VINEX DISCUS THROWING CIRCLE - ALUMINIUM
DSHC-A100 IAAF CERTIFICATE # E-08-0543



Page # 63

VINEX CONVERSION CIRCLE
VCC100 IAAF CERTIFICATE # E-13-0755





VINEX CARBON DISCUS - PRO

Vinex Carbon Discus with higher rim weight at 93% made of high quality Alloy Steel. This discus is perfect for the competitions & suitable for soft grounds or ground with grass.

- VCD-P20 2.00 kg
- VCD-P10 1.00 kg



VINEX HYPER SPIN

IAAF Certified Hyper spin is a premium quality Discus. This Discus is precisely mastered and designed with JOINTLESS rim. 91% rim weight in the Discus assists the throwers to get remarkable spin, longer distance and extra stability. This Discus features RUST PROOF ALLOY RIM with UNBREAKABLE strong plastic side plates, which makes it one of the best Discus in the world.

- VHS-200 2.000 kg
- VHS-100 1.000 kg



VINEX GOLD - 100 WOC

89% rim Weight. High quality Brass rim with yellow reinforced plastic (unbreakable) side plates and without aluminium centre plates. Used in top competitions. Vinex Gold 100 Discus features ultra high spin, when thrown with proper turn gives better results.

- DGP-B20 2.00 Kg
- DGP-B10 1.00 Kg



Awarded No. 1 by SGEPC for Highest Exports of Athletic Equipment from India





VINEX SUPER SPIN - ALLOY STEEL

85% rim weight. Superb quality ALLOY STEEL (rust proof) rim with strong black ABS plastic side plates.

DAP-200	2.000 kg	
DAP-175	1.750 kg	
DAP-150	1.500 kg	
DAP-161	1.600 kg	
DAP-100	1.000 kg	



VINEX SUPER SPIN - BRASS

85% rim weight. High quality BRASS rim with strong black ABS plastic side plates. Well balanced Discus to suit throwers of all talents. Meets IAAF specifications.

DBP-200	2.000 kg
DBP-175	1.750 kg
DBP-150	1.500 kg
DBP-160	1.600 kg
DBP-100	1.000 kg

VINEX ALUMINIUM

70% rim weight. Metal rim fitted with extra strong textured aluminium side plates. Perfectly suitable for schools and training.

Galvanized Metal Rim Alloy Steel Rim.

DSA-A20	2.000 kg	DSS-A20	2.000 kg
DSA-A16	1.600 kg	DSS-A16	1.600 kg
DSA-A10	1.000 kg	DSS-A10	1.000 kg



VINEX HIGH SPIN

75% high quality GALVANIZED STEEL rim with strong red ABS plastic side plates. Well balanced to suit any level of competition.

DSR-P20	2.000 kg	
DSR-P17	1.750 kg	
DSR-P16	1.600 kg	
DSR-P15	1.500 kg	
DSR-P10	1.000 kg	



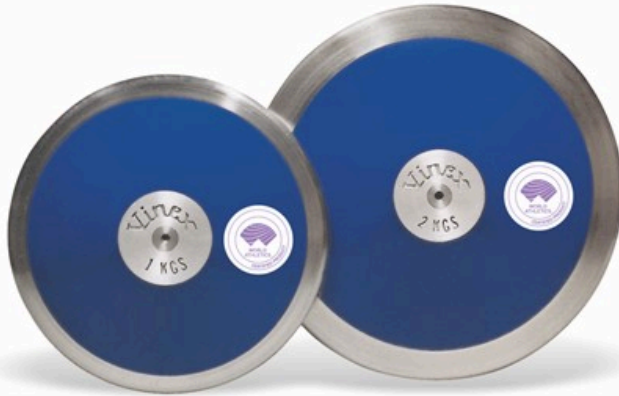

VINEX LO SPIN

70% rim weight. Galvanized steel rim with strong blue ABS plastic side plates. Ideal for Schools and Training.

DSB-P20	2.000 kg		DSB-P12	1.250 kg
DSB-P17	1.750 kg		DSB-P10	1.000 kg
DSB-P16	1.616 kg		DSB-P75	0.750 kg
DSB-P15	1.500 kg		DSB-P60	0.600 kg

VINEX PRACTICE

70% rim weight. GALVANIZED STEEL rim with extra strong plastic side plates. In economical price range. Suitable for Training.

DSG-P20	2.000 kg		DSG-P12	1.250 kg
DSG-P17	1.750 kg		DSG-P10	1.000 kg
DSG-P16	1.600 kg		DSG-P75	0.750 kg
DSG-P15	1.500 kg		DSG-P60	0.600 kg



VINEX SUPER CHALLENGE DISCUS

Discus made of galvanized mild steel rim. Side plates made of strong ABS with aluminium centre plates.

DSC-P10	1.0 kg	
DSC-P15	1.5 kg	
DSC-P20	2.0 kg	

VINEX CHALLENGE

A world class Discus at affordable prices, with strong plastic side plates and steel rim.

DCS-S20	2.000 kg
DCS-S17	1.750 kg
DCS-S16	1.600 kg
DCS-S15	1.500 kg
DCS-S12	1.250 kg
DCS-S10	1.000 kg



Awarded No. 1 by SGEPC for Highest Exports of Athletic Equipment from India





VINEX SELECT PRACTICE WOMEN - WOCP

New select series PRACTICE discus with 70% RIM weight. Features Hot Galvanized steel rim, no center plate & stronger ABS plastic plates. One of the durable practice discus available in the market.

DWP-7010 1.0 kg



VINEX SELECT LOW SPIN WOMEN - WOCP

New select series LOW SPIN discus with 75% RIM weight. Features Hot Galvanized steel rim, no center plate & stronger ABS plastic plates. One of the durable low spin discus available in the market.

DWP-7510 1.0 kg



VINEX SELECT LOW SPIN MEN - WOCP

New select series LOW SPIN discus with 75% RIM weight. Features Hot Galvanized steel rim, no center plate & stronger ABS plastic plates. One of the durable low spin discus available in the market.

- DWP-7515** 1.500 kg
- DWP-7516** 1.600 kg
- DWP-7517** 1.750 kg
- DWP-7520** 2.000 kg



VINEX SELECT HIGH SPIN WOMEN - WOCP

New select series HIGH SPIN discus with 80% RIM weight. Features Hot Galvanized steel rim, no center plate & stronger ABS plastic plates. One of the durable high spin discus available in the market.

DWP-8010 1.0 kg





VINEX SELECT HIGH SPIN MEN - WOCP

New select series HIGH SPIN discus with 80% RIM weight. Features Hot Galvanized steel rim, no center plate & stronger ABS plastic plates. One of the durable high spin discus available in the market.

- DWP-8015 1.500 kg
- DWP-8016 1.600 kg
- DWP-8017 1.750 kg
- DWP-8020 2.000 kg



ADJUSTABLE DISCUS

STEEL rim with strong red ABS plastic side plates and different weights for adjusting the overall weight for training.

- DAT-220 1.750 to 2.200 kg
- DAT-180 1.400 to 1.800 kg
- DAT-160 1.250 to 1.600 kg
- DAT-120 0.850 to 1.200 kg



VINEX LAMINATED HIGH SPIN

75% rim weight. STEEL rim with high quality water proof laminated plywood sides.

- DSL-WH20 2.000 kg
- DSL-WH17 1.750 kg
- DSL-WH16 1.600 kg
- DSL-WH15 1.500 kg
- DSL-WH10 1.000 kg

VINEX HEAVY TRAINING DISCUS

Overweight Discus suitable for training.

- VTD-250 2.5 kg
- VTD-300 3.0 kg
- VTD-350 3.5 kg





VINEX RUBBER INDOOR COLOUR

Soft and durable. Will not leave marks or damage the floor. One piece construction. Available in attractive colours: red, yellow, blue, green, orange, pink. Ideal for schools & training.

DRC-200	2.00 kg	DRC-125	1.25 kg
DRC-175	1.75 kg	DRC-100	1.00 kg
DRC-160	1.60 kg	DRC-750	0.75 kg
DRC-150	1.50 kg	DRC-600	0.60 kg



VINEX RUBBER BLACK (COLOURED CENTER)

Black rubber discus. Strong, durable and one piece solid construction with coloured center.

DRB-CC200	2.00 kg	DRB-CC125	1.25 kg
DRB-CC175	1.75 kg	DRB-CC100	1.00 kg
DRB-CC160	1.60 kg	DRB-CC750	0.75 kg
DRB-CC150	1.50 kg	DRB-CC600	0.60 kg



VINEX RUBBER BLACK

Black rubber Discus. Strong, durable and one piece solid construction.

DRB-200	2.00 kg	DRB-125	1.25 kg
DRB-175	1.75 kg	DRB-100	1.00 kg
DRB-160	1.60 kg	DRB-750	0.75 kg
DRB-150	1.50 kg	DRB-600	0.60 kg



RUBBER DISCUS WITH STRAP

Suitable for training. Includes an adjustable strap.

DWS-200	2.0 kg
DWS-160	1.6 kg
DWS-100	1.0 kg

VINEX RUBBER INDOOR BROWN/WHITE

Rubber Discus, available in brown or white colour. Soft and durable. Will not leave marks or damage the floor. One piece construction. Ideal for schools and training.

DRR/DRW-200	2.00 kg	DRR/DRW-150	1.50 kg
DRR/DRW-175	1.75 kg	DRR/DRW-100	1.00 kg
DRR/DRW-160	1.60 kg	DRR/DRW-750	0.75 kg



VINEX INDOOR DISCUS

Indoor soft Discus made of PVC, maximum weight in edges. Available in fluorescent colours.

Rim weight

DIS-200	2.000 kg	51%
DIS-150	1.500 kg	50%
DIS-160	1.600 kg	52%
DIS-100	1.000 kg	37.5%

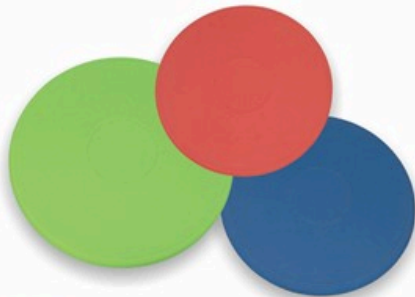



VINEX GOLD-100

Made of brass shell, lead filling. Precisely machine turned for accurate diameter and perfect balance. Self-coloured.

VSP-110	7.26 kg	110 mm
VSP-107	6.25 kg	107 mm
VSP-107A	6.00 kg	107 mm
VSP-103	5.45 kg	103 mm
VSP-195	4.00 kg	95 mm

VINEX SUPER CHALLENGE SHOTPUT

Made of cast iron precisely turned for accuracy with a smooth and painted surface.

VST-400	4.00 kg	103 mm
VST-500	5.00 kg	111 mm
VST-600	6.00 kg	118 mm
VST-726	7.26 kg	125 mm



VINEX SUPER - 200

Shell made of rust proof alloy (Stainless Steel). Precisely machine turned for accurate diameter and balance.

VSP-229	7.26 kg	129 mm
VSP-210	7.26 kg	110 mm
VSP-210A	6.25 kg	107 mm
VSP-207	6.00 kg	107 mm
VSP-203	5.45 kg	103 mm
VSP-295	4.00 kg	95 mm
VSP-209	4.00 kg	109 mm



VINEX SUPER STEEL - 500

Steel Shots precisely machine turned for accurate weight and balance. Available in different weights and diameter.

VSP-929	7.26 kg	129 mm	VSP-919	5.00 kg	119 mm
VSP-928	7.26 kg	128 mm	VSP-910	5.00 kg	110 mm
VSP-925	7.26 kg	125 mm	VSP-909	4.00 kg	109 mm
VSP-920	7.26 kg	120 mm	VSP-908	4.00 kg	108 mm
VSP-924	6.00 kg	124 mm	VSP-904	4.00 kg	104 mm
VSP-916	6.00 kg	115 mm	VSP-900	4.00 kg	100 mm



VINEX SUPER

Turned iron shots, precisely machine turned for accurate weight and diameter specifications. Available in different weights and diameter.



VSP-328	7.26 kg	128 mm	VSP-303	4.00 kg	103 mm
VSP-325	7.26 kg	125 mm	VSP-302	4.00 kg	102 mm
VSP-325B	6.00 kg	125 mm	VSP-300	4.00 kg	100 mm
VSP-320	7.26 kg	120 mm	VSP-300A	3.63 kg	100 mm
VSP-320B	6.00 kg	120 mm	VSP-308B	3.50 kg	108 mm
VSP-321	6.25 kg	121 mm	VSP-397	3.25 kg	97 mm
VSP-319	6.00 kg	119 mm	VSP-397A	3.00 kg	97 mm
VSP-308	5.45 kg	108 mm	VSP-300C	3.00 kg	108 mm
VSP-314	5.45 kg	114 mm	VSP-393	2.625 kg	93 mm
VSP-315A	5.00 kg	115 mm	VSP-388	2.500 kg	88 mm
VSP-308A	4.00 kg	108 mm	VSP-380	2.000 kg	80 mm

Heavier weights are also available. Please refer to our price list.





VINEX ECONOMY

Cast iron shots, round shaped and nicely painted. Maintains a weight tolerance of +/- 70 gm and round shape. This shot is complete value for money.

ESP-363 K	3.630 kg	ESP-545 K	5.450 kg
ESP-004 K	4.000 kg	ESP-006 K	6.000 kg
ESP-045 K	4.500 kg	ESP-625 K	6.250 kg
ESP-005 K	5.000 kg	ESP-726 K	7.260 kg

Heavier weights up to 9.5 kg and lighter weights up to 1.0 kg also available. Please refer to our price list.



VINEX TURNED ECONOMY

Cast iron solid turned shots. Accurate weight and balance. Available in economical price range. Ideal for schools and training.

TSA-300	3.00 kg	TSA-600	6.00 kg
TSA-400	4.00 kg	TSA-726	7.26 kg
TSA-500	5.00 kg		

Other sizes available on request.

VINEX SCHOOL

Cast iron unturned shots with accurate weight.

VSP-763	3.63 kg	VSP-754	5.45 kg
VSP-740	4.00 kg	VSP-760	6.00 kg
VSP-745	4.50 kg	VSP-772	7.26 kg
VSP-750	5.00 kg		

Heavier weights up to 9.5 kg & lighter weights up to 1.0 kg are also available. Please refer to our price list.



VINEX CHAIN THROWING WEIGHT

Vinex throwing weight made of turned iron ball with rust proof bearing (swivel) and comes with steel chain and handle.

VTW-S56	56 lb / 25.42 kg	VTW-S25	25 lb / 11.35 kg
VTW-S35	35 lb / 15.89 kg	VTW-S20	20 lb / 9.08 kg

VINEX THROWING WEIGHTS

Turned iron ball with rust proof bearing (swivel) and triangular steel handle.

VTW-56	56 Lbs	Green	VTW-25	25 Lbs	Blue
VTW-35	35 Lbs	Black	VTW-20	20 Lbs	Red

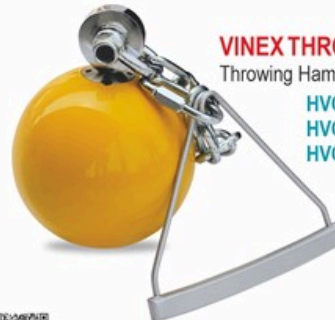

VINEX THROWING HAMMER - CHAIN

Throwing Hammer with chain for practice.

HVC-400	4.0 kg
HVC-500	5.0 kg
HVC-750	7.5 kg





INDOOR SHOT PVC NON BOUNCY WITHOUT RIB

			Colour			Colour
ISP-010GNBWR	1.00 kg	100 mm	Blue	ISP-L50GNBWR	5.00 kg	135 mm Blue
ISP-015GNBWR	1.50 kg	100 mm	Blue	ISP-0545GNBWR	5.45 kg	140 mm Blue
ISP-020GNBWR	2.00 kg	105 mm	Blue	ISP-L545GNBWR	5.45 kg	135 mm Blue
ISP-030GNBWR	3.00 kg	120 mm	Blue	ISP-L60GNBWR	6.00 kg	140 mm Blue
ISP-040GNBWR	4.00 kg	135 mm	Blue	ISP-L625GNBWR	6.25 kg	140 mm Blue
ISP-L40GNBWR	4.00 kg	125 mm	Blue	ISP-0625GNBWR	6.25 kg	145 mm Blue
ISP-050GNBWR	5.00 kg	140 mm	Blue	ISP-0726GNBWR	7.26 kg	140 mm Blue



INDOOR SHOT PVC NON BOUNCY WITH PLUG

			Colour			Colour
ISP-010GNBWP	1.00 kg	100 mm	Red	ISP-L50GNBWP	5.00 kg	130 mm Red
ISP-015GNBWP	1.50 kg	100 mm	Red	ISP-0545GNBWP	5.45 kg	135 mm Red
ISP-020GNBWP	2.00 kg	105 mm	Red	ISP-L545GNBWP	5.45 kg	130 mm Red
ISP-030GNBWP	3.00 kg	110 mm	Red	ISP-060GNBWP	6.00 kg	140 mm Red
ISP-040GNBWP	4.00 kg	125 mm	Red	ISP-0625GNBWP	6.25 kg	140 mm Red
ISP-050GNBWP	5.00 kg	135 mm	Red	ISP-0726GNBWP	7.26 kg	140 mm Red

INDOOR SHOT PVC SOLID WITH RIB

Good for Indoor, Outdoor and Training.

			Colour			Colour
ISP-200SR	0.20 kg	65 mm	Blue	ISP-040SR	4.00 kg	125 mm Orange
ISP-500SR	0.50 kg	90 mm	Orange	ISP-050SR	5.00 kg	135 mm Yellow
ISP-010SR	1.00 kg	100 mm	Red	ISP-0545SR	5.45 kg	135 mm Yellow
ISP-015SR	1.50 kg	100 mm	Red	ISP-060SR	6.00 kg	140 mm Red
ISP-020SR	2.00 kg	110 mm	Green	ISP-0625SR	6.25 kg	140 mm Red
ISP-030SR	3.00 kg	120 mm	Blue	ISP-0726SR	7.26 kg	140 mm Black

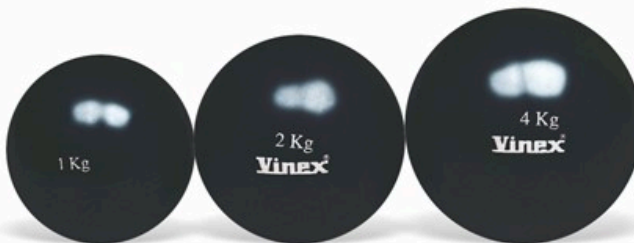

INDOOR SHOT PVC SOLID WITHOUT RIB

Good for Indoor, Outdoor and Training.

			Colour
ISP-010SWR	1.00 kg	100 mm	Black
ISP-015SWR	1.50 kg	100 mm	Black
ISP-020SWR	2.00 kg	105 mm	Black
ISP-030SWR	3.00 kg	120 mm	Black
ISP-040SWR	4.00 kg	125 mm	Black
ISP-050SWR	5.00 kg	135 mm	Black
ISP-0545SWR	5.45 kg	135 mm	Black
ISP-060SWR	6.00 kg	140 mm	Black
ISP-0625SWR	6.25 kg	140 mm	Black
ISP-0726SWR	7.26 kg	140 mm	Black

INDOOR SHOT PVC SOLID WITHOUT RIB - COLOURED

			Colour
ISP-010CSWR	1.00 kg	100 mm	Red
ISP-015CSWR	1.50 kg	100 mm	Red
ISP-020CSWR	2.00 kg	110 mm	Fluo. Green
ISP-030CSWR	3.00 kg	120 mm	Blue
ISP-040CSWR	4.00 kg	125 mm	Orange
ISP-050CSWR	5.00 kg	135 mm	Yellow
ISP-060CSWR	6.00 kg	140 mm	Red
ISP-0726CSWR	7.26 kg	140 mm	Red

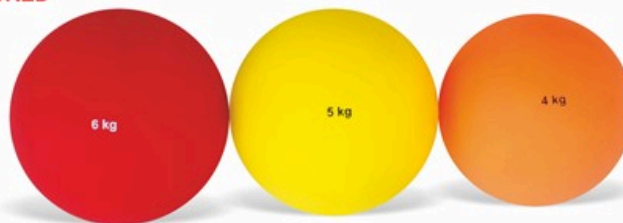

Awarded No. 1 by SGEPC
for Highest Exports of Athletic Equipment from India





VINEX GOLD - 100 BRASS SHELL

Brass Hammers manufactured to IAAF specifications. Comes with IAAF approved Hammer Handles.

HVG-400	4.00 kg	95 mm
HVG-600	6.00 kg	107 mm
HVG-726	7.26 kg	110 mm

VINEX TURNED ECONOMY IRON HAMMER

Cast iron precisely machine turned hammer for accurate weight and diameter. Comes with IAAF approved Hammer Handles.

HVI-300	3.00 kg	97 mm
HVI-300C	3.00 kg	88 mm
HVI-400	4.00 kg	102 mm
HVI-500	5.00 kg	115 mm
HVI-600	6.00 kg	115 mm
HVI-726	7.26 kg	120 mm



VINEX ECONOMY UNTURNED CAST IRON

Cast iron accurate weight hammer.

HVE-300	3.00 kg
HVE-400	4.00 kg
HVE-600	6.00 kg
HVE-726	7.26 kg



VINEX SUPER CHALLENGE HAMMER

Made of cast iron precisely turned for accuracy with a smooth and painted surface.

HVT-400	4.00 kg	102 mm
HVT-500	5.00 kg	110 mm
HVT-600	6.00 kg	116 mm
HVT-726	7.26 kg	125 mm



VINEX SUPER - 200

High quality Alloy Steel (rust proof) hammer, manufactured to International standards. Comes with IAAF approved Hammer Handles.

HVS-F40	4.00 kg	95 mm
HVS-500	5.00 kg	100 mm
HVS-600	6.00 kg	107 mm
HVS-726	7.26 kg	110 mm



VINEX HAMMER GLOVES LEATHER

HGL-111

Sizes available

Left Hand / Right Hand S, M, L and XL

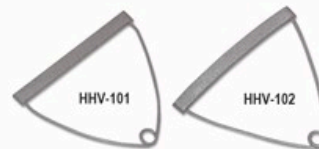

VINEX SPARE HAMMER HANDLES

HHV-101	Straight aluminium
HHV-102	Curved aluminium



VINEX SPARE HAMMER WIRES STEEL

HWG-100 3.20 mm thick

As per IAAF specifications.

Please specify length while ordering.





VINEX PRO FX

New premium starting block with centre rail made of 102 mm heavy slotted aluminium channel and thick ribs to slip in anchor plates for ensuring better ground stability. Extra large paddles for easy start with more efficiency. Comes with spikes to hold the starting block on synthetic tracks.

VSB-111



VINEX OLYMPIC MARK I

Centre rail made of special 75 mm slotted aluminium channel with ribs to slip in anchor plates ensuring high ground stability. Heavy aluminium paddles with thick rubber pads. Rust proof plates with spikes to hold the starting block on synthetic tracks / cinder tracks.

VSB-01B

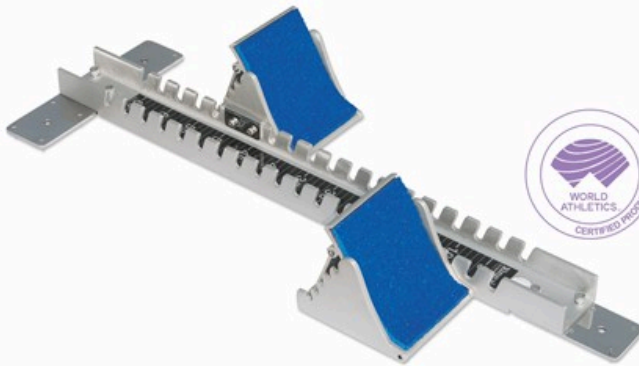
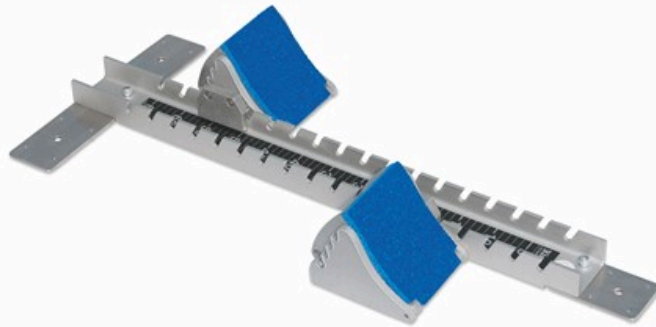

VINEX NEW OLYMPIC - MARK I

Centre rail made of 82 mm heavy slotted Aluminium Channel with thick ribs to slip in anchor plates for ensuring better ground stability. Extra broad paddles for easy start.

VSB-01N

VINEX OLYMPIC - III

Made of slotted steel channel and features light weight aluminium paddles with PVC pads. Comes with spikes to hold the starting block on synthetic tracks.

VSB-02-3



Awarded No. 1 by SGEPC
for Highest Exports of Athletic Equipment from India



VINEX INTERNATIONAL

Centre rail made of heavy 82 mm heavy slotted aluminium channel with thick ribs to slip in anchor plates to ensure high ground stability. Heavy aluminium paddles with thick rubber pads. In built handle for easy carrying. Spikes to hold the starting block on synthetic tracks / cinder tracks.

VSB-01H

VINEX PRO-PLUS

Made of 100 mm heavy aluminium slotted channel, heavy weight aluminium paddles with thick PVC pads. Rust proof plates with spikes to hold the starting block on synthetic and cinder tracks.

VSB-01A

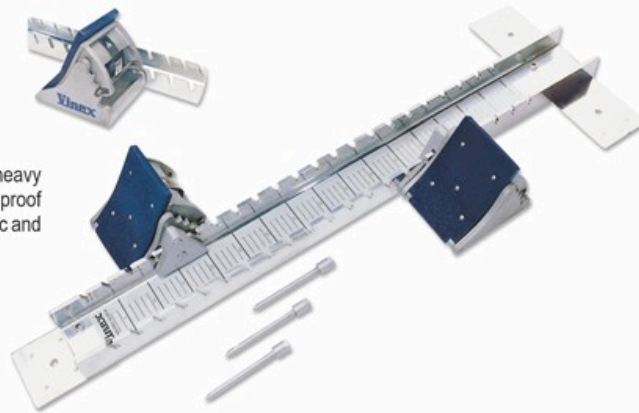

VINEX OLYMPIC MARK II

Made of 75 mm aluminium slotted channel, light weight aluminium paddles with thick PVC pads. Rust proof plates with spikes to hold the starting block on synthetic tracks.

VSB-01C

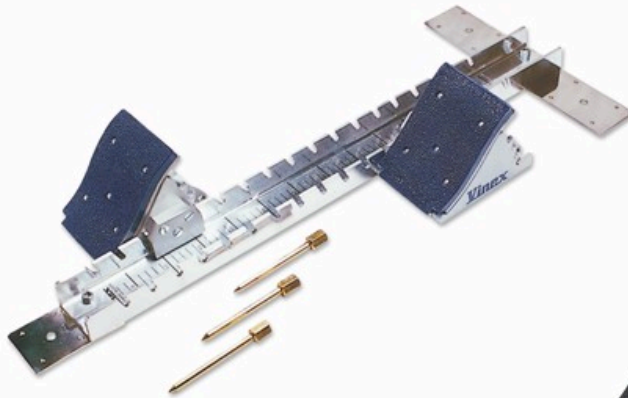

VINEX OLYMPIC MARK III

Made of 62 mm aluminium slotted channel, light aluminium paddles with thick PVC pads. Rust proof plates with spikes to hold the starting block on synthetic tracks.

VSB-01D

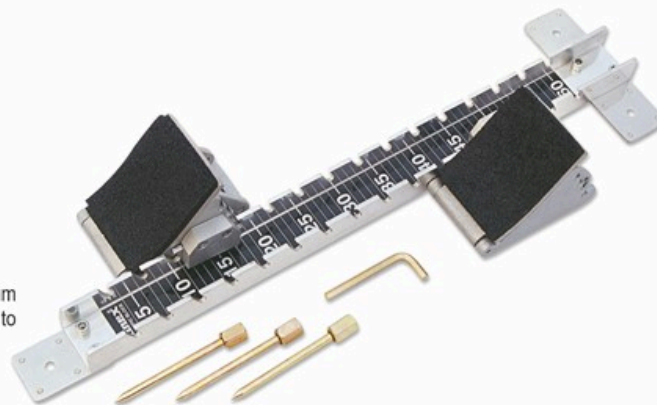

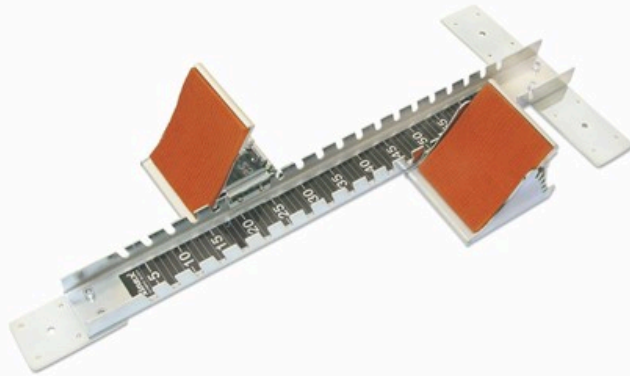

VINEX NEW OLYMPIC MARK II

Centre rail made of mild steel (galvanized) with extra broad paddles for extra foot support.

VSB-02N

VINEX OLYMPIC MARK IV

Made of slotted steel channel, light weight aluminium paddles with thick PVC pads. M.S. chromium plates with spikes to hold the starting block on synthetic tracks.

VSB-02

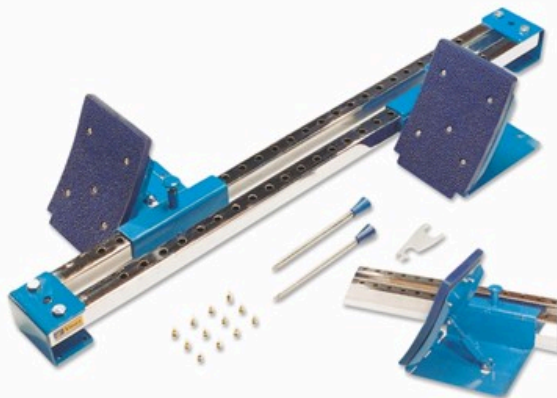

VINEX CLASSIC

Made of double square steel tubes, M. S. steel paddles with PVC pads, both ends with spikes suitable for synthetic tracks.

VSB-04

VINEX TRI STAR

Made of heavy duty STEEL. Three paddles for convenient start. No hassles of paddle adjustment, powder coated for durable finish. Can be used for both synthetic and cinder tracks.

VSB-03P

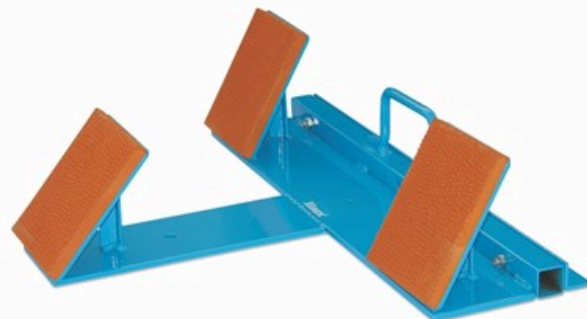

Awarded No. 1 by SGEPC
for Highest Exports of Athletic Equipment from India





VINEX JET

Made of slotted galvanized steel channel, blocks made of extra thick poly-propylene for maximum durability, suitable for any track.

VSB-22

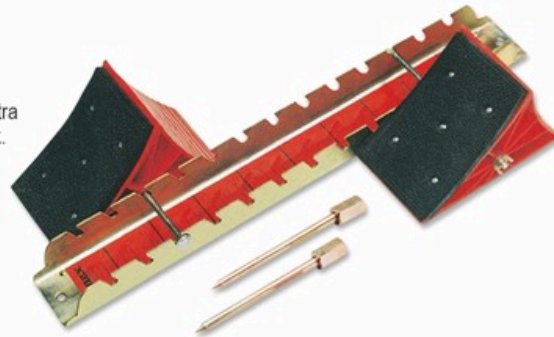

VINEX PREMIUM - MARK I

Casted aluminium centre rail and aluminium paddles with rubber pads. Adjustable at different positions. Attachment for synthetic tracks also available.

VSB-03A

VINEX PROFESSIONAL

Made of double square steel tubes, casted aluminium paddles with PVC pads, suitable for all tracks.

VSB-05

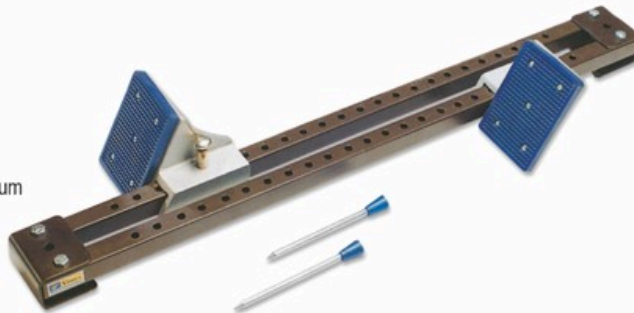

VINEX PROFESSIONAL - S

Made of double square steel tubes, thick M.S. sheet paddles with PVC pads, suitable for all tracks.

VSB-05S





VINEX RACER ALUMINIUM

Made of slotted aluminium channel, casted aluminium paddles with thick rubber pads, suitable for all tracks.

VSB-08A

VINEX RACER

Made of slotted steel channel, plastic paddles with PVC pads, suitable for all tracks.

VSB-08



VINEX SUPER

Made of square aluminium tube, casted aluminium paddles with PVC pads, suitable for all tracks.

VSB-07



VINEX RUBBER

Made of solid rubber. Suitable for schools / beginners.

VSB-11





VSA-600 Anchor Nail



SPIKES

PACK OF 100

- VS1/8-N8401
- VS3/16-N83601
- VS1/4-N838
- VS3/8-N839
- VS3/16-P83602
- VS1/8-P840
- VS1/2-P841
- VS1/4-P842
- VS3/8-P843
- VS5/8-P844
- VS8-848

- 1/8" Needle point
- 3/16" Needle point
- 1/4" Needle point
- 3/8" Needle point
- 3/16" Pyramid
- 1/8" Pyramid
- 1/2" Pyramid
- 1/4" Pyramid
- 3/8" Pyramid
- 5/8" Pyramid
- Blanks



VINEX GOLD - 100

Aluminium pipe smoothly turned from both the ends, anodized. Available in 8 different colours.

- RBA-S08
- RBA-S06
- RBA-J08
- RBA-J06

- Senior set of 8 pieces
- Senior set of 6 pieces
- Junior set of 8 pieces
- Junior set of 6 pieces



VINEX SUPER - 200

Made of plastic with rounded ends. Available in different colours.

- RBP-S08
- RBP-S06
- RBP-J08
- RBP-J06

- Senior set of 8 pieces
- Senior set of 6 pieces
- Junior set of 8 pieces
- Junior set of 6 pieces



VINEX CLASSIC

Made of Aluminium pipe smoothly turned from both ends, powder coated. Available in 8 different colours.

- RBA-S08PC
- RBA-S06PC
- RBA-J08PC
- RBA-J06PC

- Senior set of 8 pieces
- Senior set of 6 pieces
- Junior set of 8 pieces
- Junior set of 6 pieces





VINEX AUTOMATIC HURDLE - PRO

Superior quality professional automatic hurdle for competitions. Made of heavy gauge rounded corners square aluminum alloy tube with automatic weight adjustment. New unique snap lock system for easy adjustment of height, without bending too low to adjust the hurdle heights unlike regular hurdles.

VSH-1000



VINEX HURDLE PRO ALUMINIUM

Vinex Club - All Aluminum Hurdle, polyurethane painted. PVC counter weights adjust to meet precise official pullover force at each of the 5 heights. Height is adjustable by easy snap locking mechanism. Special design makes it easy to stack in minimum space.

VSH-A222 Fixed



Awarded No. 1 by SGEPC
for Highest Exports of Athletic Equipment from India



VINEX OLYMPIC - AUTOMATIC

Superior quality competition hurdle made of Heavy Gauge semi-circular Aluminum Alloy Tube with wider flat base for superior stability on the ground. Weight of the Hurdle adjusts automatically according to the height as per regulation Tip-over position.

VSH-666



VINEX VELOCITY

Vinex Velocity All Aluminium Hurdle offers a special design which makes it one of the safest hurdles. This hurdle offers extra strong elbows which give this hurdle more strength and durability. Folding design of Vinex Velocity reduces the volume of the hurdles, which saves cost on space / transportation. It also features Lexan Gateboard and PVC coated counter weights with better stacking ability. 5 height adjustments as per IAAF rule.

VSH-101

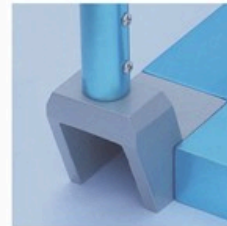



VINEX PRO HURDLE

Strongest hurdle made of 50 mm square steel tube, polyurethane painted. (Galvanized version also available). PVC coated counter weights adjust to meet precise official pullover force at each of the 5 heights. Height is adjustable by easy snap locking system. Special design makes it easy to stack in minimum space.

Vinex PRO HURDLE is backed by IAAF confidence and has the experience of many international meets and that too at an attractive price.

VSH-222FX Fixed



VINEX PRO HURDLE

Strongest hurdle made of 50 mm square steel tube, zinc plated. Height is adjustable by easy snap locking system upto four levels. PVC coated counter weights adjust to meet precise official pullover force at each of the 5 heights. Folding design of Vinex Pro Hurdle reduces the volume of the hurdles, which saves cost on space / transportation.

Vinex PRO HURDLE is backed by IAAF certification & has the experience of many International and National meets. Available at an attractive price.

VSH-222HG Foldable

Awarded No. 1 by SGEPC
for Highest Exports of Athletic Equipment from India





VINEX SPRING RETURN HURDLE

Made of 20 mm square steel tube, powder coated frame for durability & easy height selection by snap locking method. Uprights are made of 22 mm Aluminium Round tube. Spring mechanism helps the hurdle to come back to its position when knocked down by athlete. The hurdle comes with **Five** different height adjustments. Available in 2 sizes

VSH-S777 SENIOR : 0.762 m - 1.067 m
VSH-J777 JUNIOR : 0.450 m - 0.686 m



VINEX ALUMINIUM PRACTICE HURDLE

A light weight Aluminium hurdle, best for practice. It features natural anodizing and **Five** different height adjustments (as per IAAF specifications). It can be easily assembled & dismantled and comes neatly packed in a box for easy storage & transportation.

VSH-A119



VINEX SELF TRAINING HURDLE

This hurdle helps the hurdler to jump over the hurdle with correct body position. The upright over the hurdles keeps hurdler's arm movement in control and velcro attached web tape on top makes hurdler bring trail leg under armpit. It is available as a complete set including Hurdle and also as a Top Part attachment only to fit on other Vinex hurdle models.

VSH-ST100 Complete Set
VSH-STPO Top Part only





VINEX COMPETITION

Extra strong hurdle with 50 mm flat steel base. Powder coated frame. Easy height selection by snap locking mechanism. PVC coated counter weights meet precise official pullover force at all 5 heights.

VSH-444

VINEX ROLLBACK - ALUMINIUM

This hurdle is made of Aluminium, is light weight yet sturdy. The bounce back feature of this hurdle makes it one of the best hurdles for school level competitions & practice. It features natural anodizing, lexan gateboard, 5 height adjustments as per IAAF rule. This hurdle packed in a box in dismantled state. Can be easily assembled/dismantled for easy storage and transportation.

VSH-555



VINEX SCHOOL

This hurdle is made of steel, is light weight yet sturdy. This is one of the best hurdles for school level competitions & practice. It features galvanized hurdle legs, powder coated top and plastic gateboard with 5 height adjustments as per IAAF rule. This hurdle comes packed in a box in dismantled state. Can be easily assembled/dismantled for easy storage and transportation.

VSH-888





VINEX COLLAPSIBLE

This hurdle collapses if knocked. Made of square Steel tube, featuring galvanizing and powder coating for durability. Comes in 5 heights as per IAAF specifications.

VSH-999



VINEX CHAMPIONSHIP

Made of Extra strong 50 mm square steel tube. Powder coated frame. Easy height selection by snap locking mechanism. Gate tube made of steel for extra durability. P.V.C. coated counter weights meets precise official pullover force at all 5 heights.

VSH-707



NEW PREMIUM

Designed for maximum durability. Detachable legs made of round steel tubular pipe make the hurdle easier in transportation. Adjustable weight for different heights varying from 0.762 to 1.067 meters, galvanized to prevent rusting, sliding tube with spring loaded plastic locks for quick adjustment of height.

VSH-111A





PREMIUM

International quality hurdle with hinged legs made of round steel tubular pipe with adjustable weight. 5 height adjustments as per IAAF rule. Zinc plated to prevent from rusting. Sliding tube with spring loaded plastic lock for quick adjustment of height. Vinex Premium hurdle is best suitable for professionals.

VSH-111



CLASSIC

Best quality hurdle used for practice and competitions. Inside concealed weights help the hurdle to come back when knocked by the athlete. Easy height adjustment by spring loaded plastic locks. 5 height adjustments as per IAAF rule.

VSH-112



ELEMENTARY SUPER

Hurdle with compact base and sliding tube. Height adjusted by concealed push-buttons. Height adjustable at 45 cm, 50 cm, 55 cm, 60 cm, 65 cm and 70 cm.

VSH-113E



SUPER-200

Hurdle with compact base and sliding tube. Height adjusted by concealed push-buttons. 5 height adjustments as per IAAF rule.

VSH-113



SPARE HURDLE CROSSBARS / GATEBOARD

Lexan gateboard suitable for all models of Vinex Hurdles except Scissor Hurdle.

VSH-SPBL

PVC gateboard suitable for Scissor Hurdle models.

VSH-SPBSL

Please confirm Model No. of Hurdle while ordering Crossbars.





CLUB

The special design of this hurdle makes it one of the best hurdles for school level competition & practice. It features powder coated paint, fixed weighted base, lexan gateboard & 5 height adjustments as per IAAF rule. This hurdle is detachable from the base which makes the transportation of the hurdle easier & economical.

VSH-333

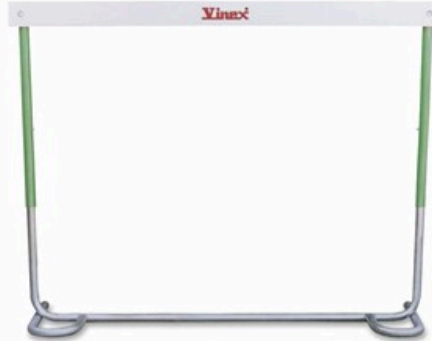

GOLD-100

Steel hurdle, light weight, 5 height adjustments as per IAAF rule by concealed push-buttons. Ideal for schools.

VSH-114L

LEXAN GATEBOARD



GOLD-100 JUNIOR

Steel hurdle, light weight, height adjustment by concealed push-buttons height varies from 45 cm to 68 cm.

VSH-114JL

LEXAN GATEBOARD

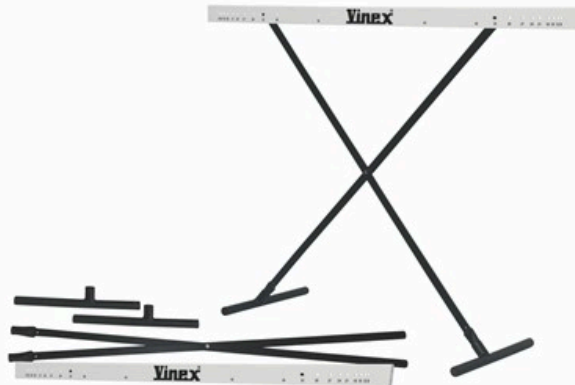

SCISSOR SUPERB

Scissor type hurdle made of heavy steel strip with legs made of round steel tube. Legs can be detached easily using a snap lock mechanism. Comes in a compact packaging for easy transportation. Height range 9" to 42"

VSH-177



TRAINING

Scissor type hurdle made of round steel tubular pipe. Height range 9" to 36"

VSH-115



SCISSOR ECONOMY

Scissor type hurdle made of steel strip. Height range 9" to 36"

VSH-116





VINEX TRAINING HURDLE - SELFTRA

Training hurdle made of tubular steel which can be used at three different heights - 25 cm, 30 cm & 40 cm by simply turning the hurdle to 3 different sides. All the front sections are covered with foam. This hurdle is excellent for training purpose. Comes flat packed for economical transportation and easy storage with help of attached snap lock.

Sizes: 25cm, 30cm and 40 cm.

VSH-S0001 1 pc

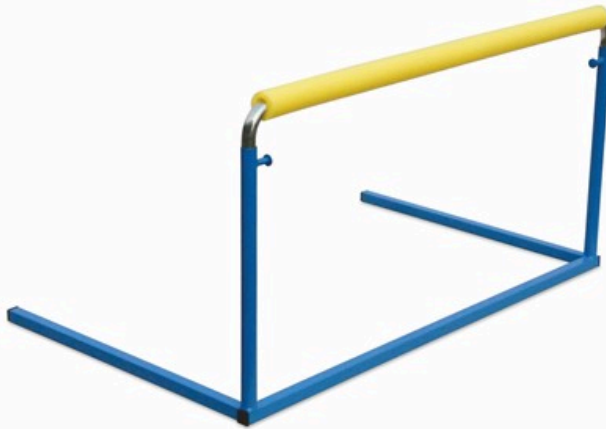
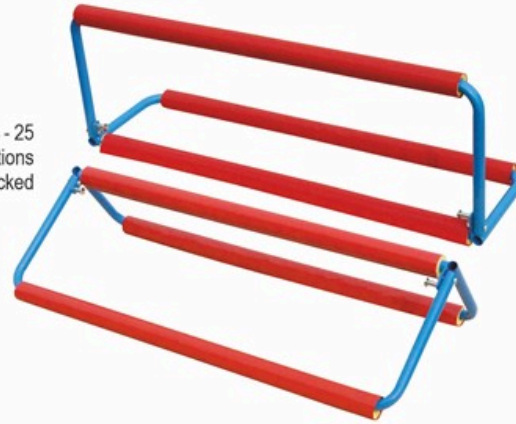

VINEX TRAINING HURDLE - ETOS

This hurdle is made of steel. Powder coated frame. Easy height selection by snap locking mechanism with foam covered crossbar. Weighted legs for better stability on the surface. Adjustable to 4 heights from 60 cm to 100 cm.

VHS-ET60100 1 pc

VINEX TRAINING HURDLE - ECOS

Hurdle made of heavy "SEP" tube and crossbar made of webbing attached with strong steel connectors. Tubes are inserted to the weighted T-bases, which ensure stability of the hurdle. Available in 2 different variants with adjustable height.

VTH-ECS SENIOR
VTH-ECJ JUNIOR



VINEX AGILITY 3-in-1 HURDLE - REGULAR

Training hurdle made of heavy duty plastic tube which can be used at three different heights - 25 cm, 30 cm & 40 cm by simply turning the hurdle to 3 different sides. Comes flat packed for economical transportation and easy storage.

AGH-3N1R 1 pc





VINEX JUNIOR STEEL HURDLE - CLUB

This hurdle is made of steel, is light weight yet sturdy & powder coated for extra durability. Hurdle is 60 cm wide. It is an ultimate product for training and physical activities. Special feature of this hurdle is its foldable legs, which make it easier to store and transport. Available in 10 heights versions, with each hurdle having 1 height.



		Width	Height
VSH-CLB12	Each pc	60 cm	12 cm
VSH-CLB14	Each pc	60 cm	14 cm
VSH-CLB16	Each pc	60 cm	16 cm
VSH-CLB18	Each pc	60 cm	18 cm
VSH-CLB20	Each pc	60 cm	20 cm
VSH-CLB22	Each pc	60 cm	22 cm
VSH-CLB24	Each pc	60 cm	24 cm
VSH-CLB26	Each pc	60 cm	26 cm
VSH-CLB28	Each pc	60 cm	28 cm
VSH-CLB30	Each pc	60 cm	30 cm
VSH-CLBS10	Set of 10 Hurdles		

VINEX JUNIOR HURDLE - MAGNETIC

Vinex Junior Hurdle-Magnetic made from steel and with magnetic crossbar. Crossbar drops down if hit by player to avoid injuries for a player. Easily adjustable at 5 different height : 40 cm, 45 cm, 50 cm, 55 cm & 60 cm.

VSH-JMH5W60



VINEX ALUMINUM BOUNCE BACK HURDLE- ELITE

Vinex Elite Bounce Back Hurdle made of lightweight Aluminum tube. The hurdle bounces back to its position when knocked down. It features adjustable height and comes flat packed for economical transportation and easy storage.

VABBH-ELS	Small:	76 cm (W) x 40 cm to 60 cm (H)
VABBH-ELM	Medium:	84 cm (W) x 54 cm to 84 cm (H)
VABBH-ELL	Large:	89 cm (W) x 65 cm to 107 cm (H)



VINEX BOUNCE BACK HURDLE - ETOS

New aluminium bounce back hurdle, returns to its position if knocked down by an athlete. This hurdle is made of aluminium telescopic tubes with linear grooves to make it easier to reach the snap lock hole without having to match the positions. Faster & easier to adjust at different heights.

	Width	Adjustable Heights
VBBH-ETOS01 - Small	76 cm	45 cm / 50 cm / 55 cm / 60 cm
VBBH-ETOM01 - Medium	84 cm	65 cm / 70 cm / 75 cm / 80 cm / 85 cm
VBBH-ETOL01 - Large	89 cm	70 cm / 75 cm / 80 cm / 85 cm / 90 cm / 95 cm / 100 cm / 105 cm





STEEPLECHASE BARRIERS

Barrier beam made of 100 mm x 100 mm Steel Tube, covered with water proof plywood. Base legs have spring loaded snap-locks for easy height (3 heights) adjustment.

- ① SCB-100 Painted
- ② SCB-100EPDM EPDM



VINEX WATER BARRIERS

Heavy duty foldable beam made up of square pipe covered with thick waterproof solid plywood. Base legs and base are made of steel square pipe with spring loaded snap lock system for easy adjustment of three different required heights i.e. 762 mm, 838 mm & 914 mm. Legs are fitted into sockets grouted in the ground. Painted with premium quality polyurethane paint for longer life and durability. Easy to install and foldable for easy transportation.

- VTWB-100 Painted
- VTWB-100EPDM EPDM



Awarded No. 1 by SGEPC for Highest Exports of Athletic Equipment from India



VINEX FOAM HURDLE - CLUB

Training hurdle made of foam, covered with heavy duty vinyl. Comes with height adjustment of 30", 33", 36" and 39". Can be used indoor and outdoor.

VFH-CLB100 Complete set

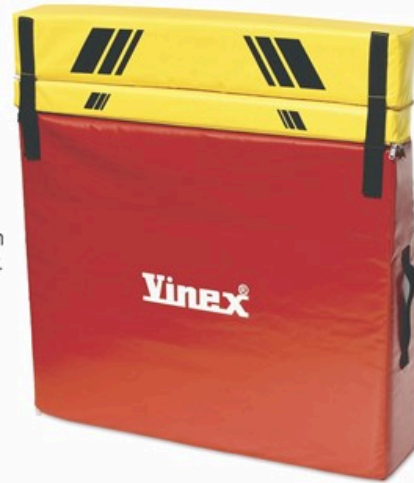

VINEX FOAM PLYOMETRIC BOX

Plyometric box made of foam and covered with heavy duty vinyl. Its perfect to start doing box jumps, box push-ups, dips, step ups and other creative exercises. Comes in a set of 4 foams (6", 12", 18" and 24")

VPMB-F100	Complete set	VPMB-F18	18"
VPMB-F6	6"	VPMB-F24	24"
VPMB-F12	12"		

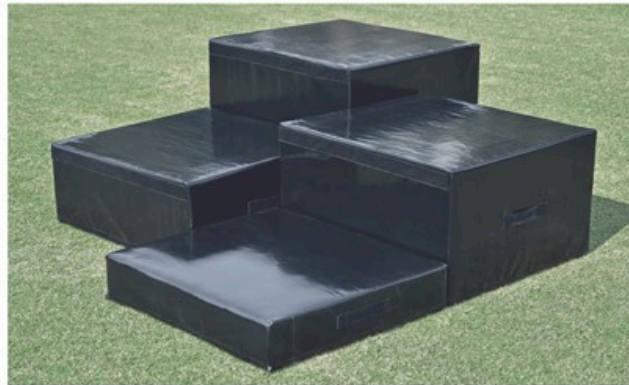

VINEX PLYOMETRIC BOX - SUPER

Made of 25 mm square tube, fully welded frame and top covered with fabric. Powder coated for extra durability. One set includes 1 pc each of 12", 18", 24", 30" & 36" high, stackable platforms.

VPMB-100





Vinex® Competition Javelins®

Made of hardened best quality dura aluminium. Designed and crafted for maximum throw distance. Javelin head made of stainless steel for extra durability. Conclusively, one of the best available Javelins.

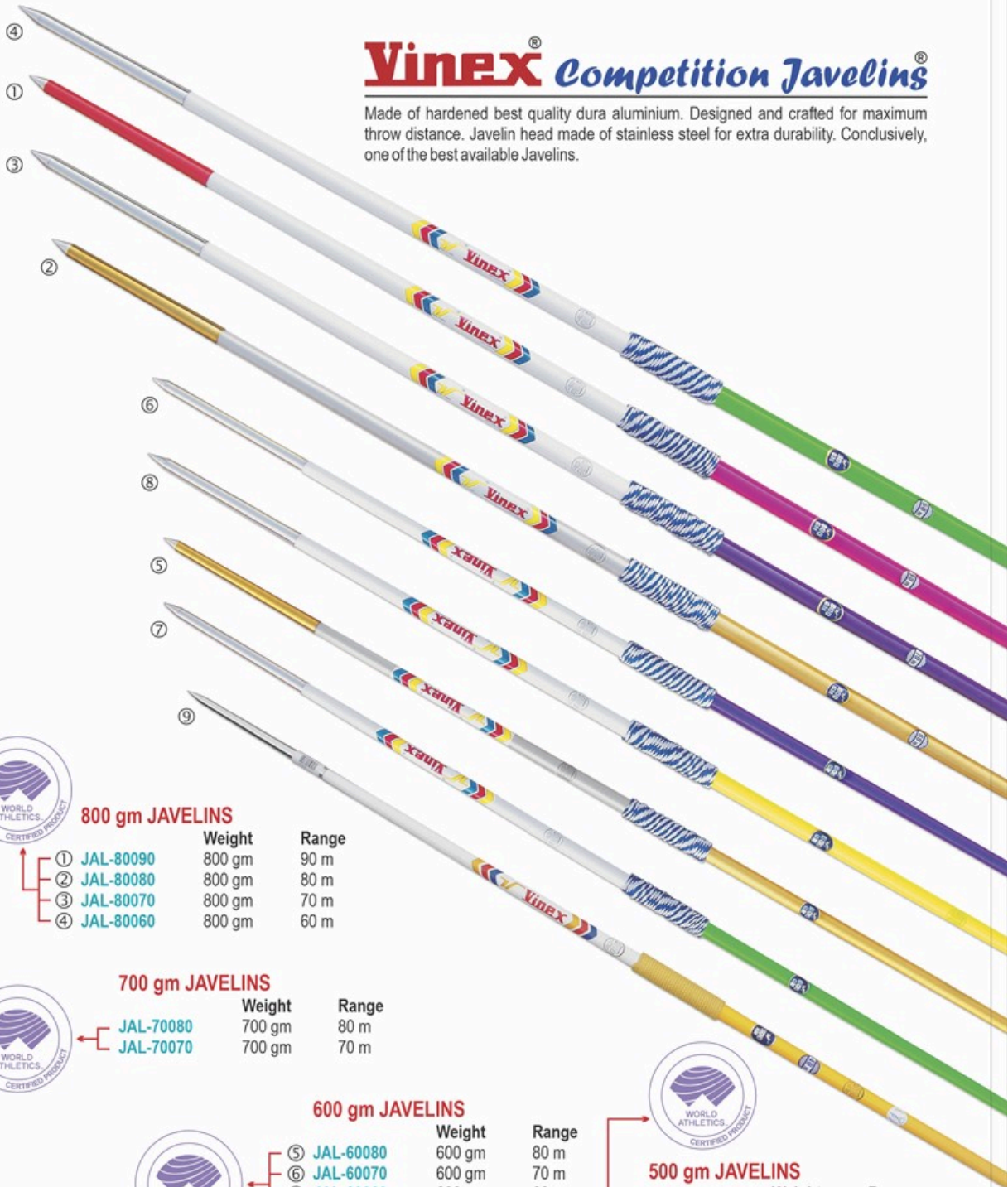

800 gm JAVELINS

	Weight	Range
① JAL-80090	800 gm	90 m
② JAL-80080	800 gm	80 m
③ JAL-80070	800 gm	70 m
④ JAL-80060	800 gm	60 m



700 gm JAVELINS

	Weight	Range
JAL-70080	700 gm	80 m
JAL-70070	700 gm	70 m



600 gm JAVELINS

	Weight	Range
⑤ JAL-60080	600 gm	80 m
⑥ JAL-60070	600 gm	70 m
⑦ JAL-60060	600 gm	60 m
⑧ JAL-60050	600 gm	50 m



500 gm JAVELINS

	Weight	Range
⑨ JAL-50040	500 gm	40 m

Awarded No. 1 by SGEPC
for Highest Exports of Athletic Equipment from India





VINEX SUPER CHALLENGE JAVELIN

Made of hardened best quality Dura aluminum. Design and crafted for maximum throw distance. Javelin head made of steel for extra durability.



- ◀ **JAL-CH600** 600 gm
- ◀ **JAL-CH700** 700 gm
- ◀ **JAL-CH800** 800 gm



Vinex AERO

VINEX AERO JAVELIN

New Vinex AERO Javelins are made of **SPECIAL ALUMINIUM** alloy for extra durability and stability.

- | | | | |
|------------------------|---------------|------------------------|----------------|
| JAL-C800 800 gm | Blue + White | JAL-C500 500 gm | Yellow + White |
| JAL-C700 700 gm | Green + White | JAL-C400 400 gm | Orange + White |
| JAL-C600 600 gm | Red + White | JAL-C300 300 gm | Orange + White |



VINEX PRACTICE JAVELIN

New practice javelin made of aluminium with rubber shoe for turf fields.

- JAL-1800** Weight - 800 g
- JAL-1700** Weight - 700 g
- JAL-1600** Weight - 600 g
- JAL-1500** Weight - 500 g
- JAL-1400** Weight - 400 g
- JAL-1300** Weight - 300 g





ELEMENTARY FOAM JAVELIN

Elementary Javelin made of foam tube. **Tube size : 90 cm x 5 cm**

VEJ-F905



ELEMENTARY FOAM JAVELIN - SOLID

Vinex Elementary Foam Javelin made of 50mm solid tube. **Tube Size : 95 cm x 5 cm**

- ① **VEJ-F905SO** 1 pc
- VEJ-F905SOPK6** Pack of 6 pc

Vinex Elementary Foam Javelin made of 50mm solid tube. **Tube Size : 50 cm x 5 cm**

- ② **VEJ-F50SO** 1 pc
- VEJ-F50SOPK6** Pack of 6 pc

Available in different colours, please ask for more details.



VINEX KIDS PLASTIC JAVELIN

Vinex Kids Plastic Javelin Made of Strong Plastic. **Length: 70 cm ; Weight: 300 Grams**

VEJ-P70 1Pc



VINEX KNOCKEN BALLS

For training / practice of javelin. Designed to give the feeling of a javelin while throwing indoors.

- JKB-400** 400 gm Pink
- JKB-800** 800 gm Red
- JKB-600** 600 gm Yellow
- JKB-01K** 1.00 kg Blue



JAVELIN BALL - 65 mm PVC

PVC javelin ball best for indoor use.

- ISP-80SWR** 80 gm
- ISP-120SWR** 120 gm
- ISP-150SWR** 150 gm



JAVELIN BALL - HARD PVC

Hard PVC javelin ball, does not damage the floor.

- JBB-400** 400 gm
- JBB-600** 600 gm
- JBB-800** 800 gm



JAVELIN BALL - PVC

PVC javelin ball best for indoor use.

- JBP-400** 400 gm
- JBP-600** 600 gm
- JBP-800** 800 gm



JAVELIN BALL - NON BOUNCY

Indoor javelin ball, PVC shell filled with Lead/Iron pellets.

- JBR-400** 400 gm
- JBR-600** 600 gm
- JBR-800** 800 gm



JAVELIN BALL - OUTDOOR

Outdoor javelin ball. Well painted iron ball.

- JBS-400** 400 gm
- JBS-600** 600 gm
- JBS-800** 800 gm





FIBREGLASS CROSSBAR

IAAF CERTIFICATE # E-04-0382

Fibreglass Crossbar made in single piece through poltrusion process for minimum sag and extra durability.

Crossbar is not guaranteed against breakage.

- VFG-C4 4.0 m
- VFG-C45 4.5 m



VINEX FIBREGLASS CROSSBAR - SELECT

Fibreglass crossbar for practice, made in single piece as per IAAF specifications with black colour rubberized end caps.

Crossbars are not guaranteed against breakage.

- VFG-SL4M 4.0 m



VINEX FIBREGLASS CROSSBAR FOLDING

Vinex fibreglass crossbar made in 3 folding parts for easy storage and transportation. **Crossbar is not guaranteed against breakage.**

- CFG-FC4 4.0 m



CBH-F33



CBS-F22



CBA-S44

CROSSBAR

- CBH-F33 Aluminium folding super 25 mm-Hard paint.
- CBS-F22 Steel folding - Round.
- CBA-S44 30 mm aluminium with plastic ends - 4 m single length.
- CBA-S45 30 mm aluminium with plastic ends - 4.5 m single length.



CROSSBAR ROPE

- ① CBR-D15 Crossbar 15' P. P. ROPE & durahyde covers weighted with sand.
- ② CBR-ED15 Crossbar 15' ELASTIC ROPE & durahyde covers weighted with sand.



ELASTIC CROSSBAR

Made of elastic cord with 6" x 1" foam sections, overall length 15'

- CBF-E15 Black digits only.
- CBF-E15BW Alternating Black & White digits.



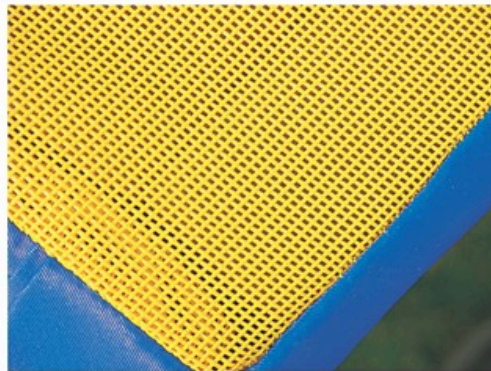

HIGH JUMP VINEX LANDING AREA / PIT - INTERNATIONAL

Made of best quality non-tear water proof thick fabric, P.U. foam. Especially designed for smooth and soft landing as per new IAAF specifications. Comes with spike proof top, Cover made of vinyl coated fabric for extra durability. Top of Base Unit is also covered with Vinyl coated woven polyester mesh fabric for superior strength. Mesh top allows desired escape of air to provide maximum compression on landing. Consists of three base units, each with four side handles for easy carrying and one top pad.

- VHJP-700 (600 cm x 400 cm x 70 cm) - IAAF CERTIFICATE # E-05-0414
- VHJP-702 (550 cm x 300 cm x 70 cm)
- VHJP-703 (500 cm x 300 cm x 60 cm)



VINEX HIGH JUMPING LANDING AREA / PIT - RAIN COVER

Rain Cover for High Jump Pit.

- VHJP-700RC (600 cm x 400 cm x 70 cm)
- VHJP-702RC (550 cm x 300 cm x 70 cm)
- VHJP-703RC (500 cm x 300 cm x 60 cm)

Awarded No. 1 by SGEPC
for Highest Exports of Athletic Equipment from India





HIGH JUMP STAND OLYMPIC

Solid, telescopic pillar construction made of Special Aluminium profiles, anodized in silver colour. Measuring tape installed in the special C-shaped groove in aluminium profile which protects it against damages made by abrasion or accidental overturn. Two brackets for putting a crossbar - one comply with arrow indications, the other one is mounted 50 cm lower. Stand base made of heavy duty steel, powder coated. Wheels installed in the base enable easy movement. Special, self-blocking mechanism of lifting and lowering crossbar brackets by means of crane lever. This ensures comfortable operating and precise height adjustment. **Height adjustment from 115 cm to 265 cm.**

HJS-A11

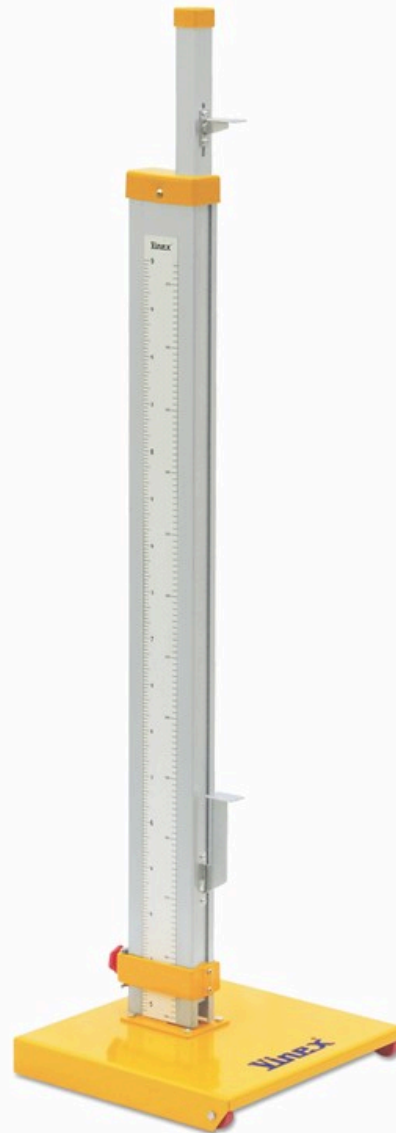

HIGH JUMP STANDARD SUPREME

Uprights made of special aluminium telescopic pillar construction profiles, which are bolted with 18" square roll away steel base and includes two brackets to place the crossbar, heavy duty construction for maximum stability. Comes un-assembled and can be assembled very easily by screwing four screws. **Height adjustment from 160 cm to 270 cm.**

HJS-S01





HIGH JUMP STAND - COMPETITION

IAAF CERTIFICATE #E-04-0381

Heavy gauge steel uprights. High Jump standards with 18" steel square base. Steel constructed risers with welded bar rests. Complies with International standards. **Approved by IAAF.**

Height adjustment from 70 cm to 260 cm.

HJS-XXX

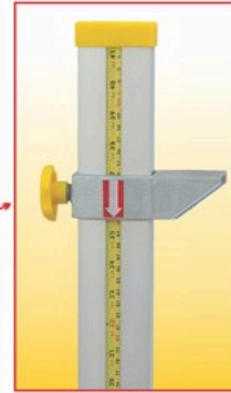

HIGH JUMP STAND - CLUB

Upright made of Anodized Aluminium profile with in-built Metal Measuring Tape. Heavy base made of steel, powder coated for extra durability. **Height adjustment from 15 cm to 200 cm.**

HJS-A55

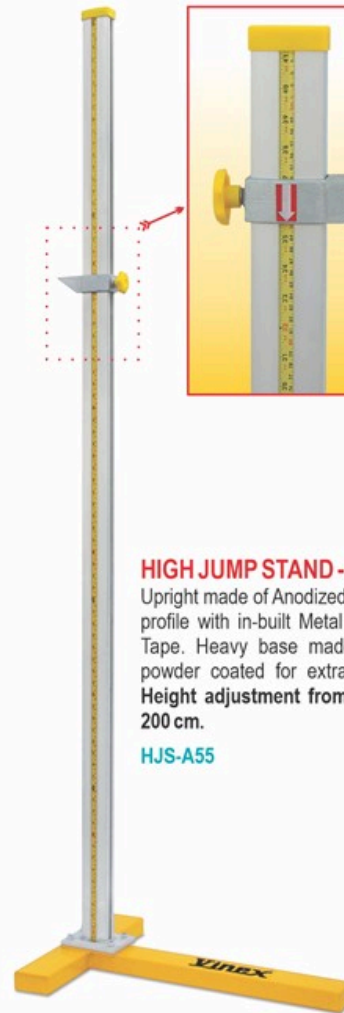

VINEX GOLD - 100

Aluminium 1.5 inches square tubular pipe. Base made of rectangular steel pipe with weight. **Height adjustment from 30 cm to 200 cm.**

HJS-A66



VINEX SUPER - 200

As above in all steel tubular pipe construction. **Height adjustment from 30 cm to 200 cm.**

HJS-A77



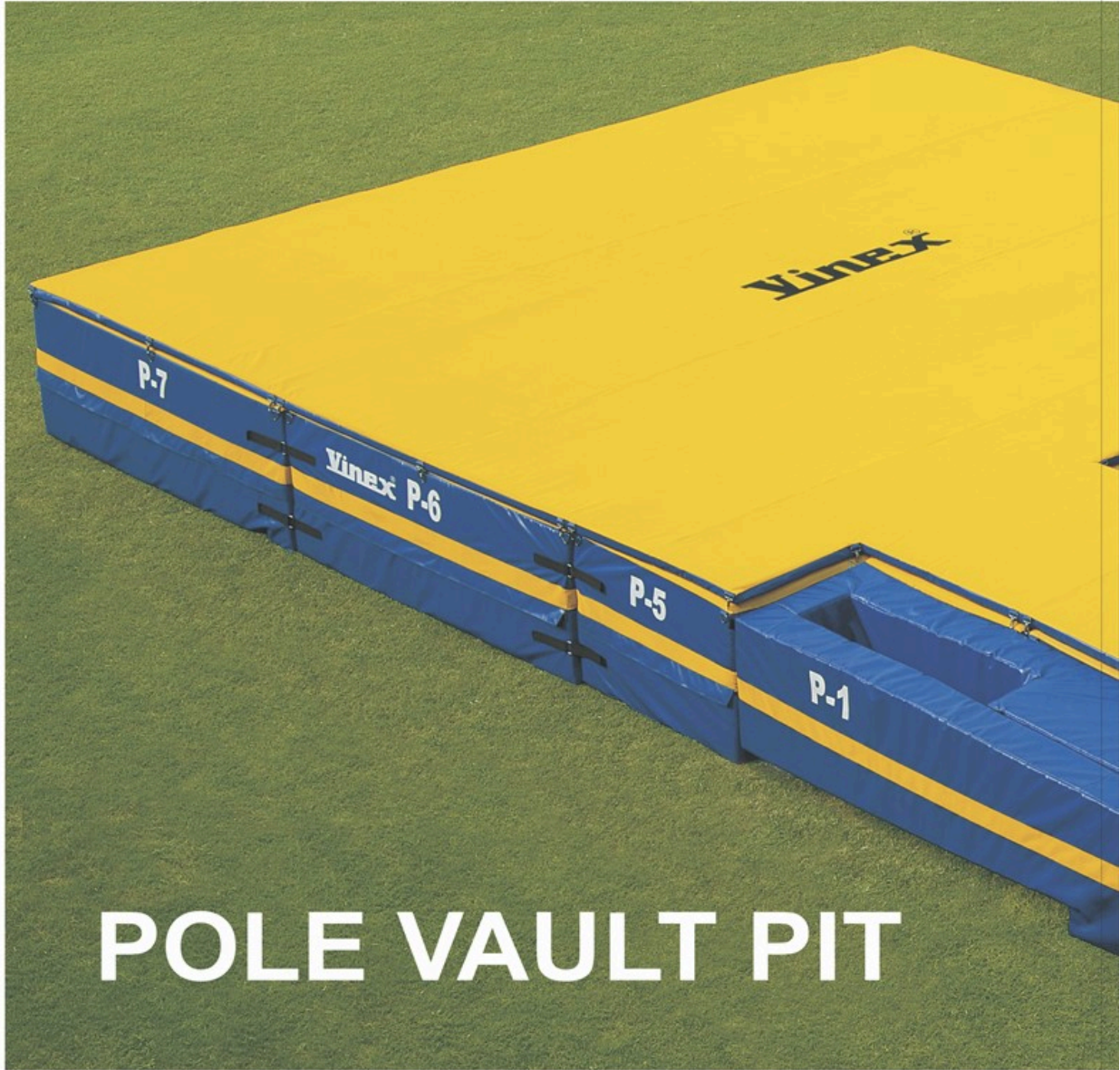

POLE VAULT PIT

POLE VAULT PIT - COMPETITION

This pit is made of best quality non-tear water proof thick fabric, P.U. foam. The special design of this pit allows smooth and soft landing and is made as per the new IAAF specifications. Comes with spike proof top. Cover made of vinyl coated fabric for extra durability. Consists of seven base units and one top pad with four side handles on each base for easy carrying.



- ← **VPVP-700** (600 cm x 800 cm x 80 cm)
- IAAF CERTIFICATE # E-05-0413**
- VPVP-702** (680 cm x 500 cm x 80 cm)



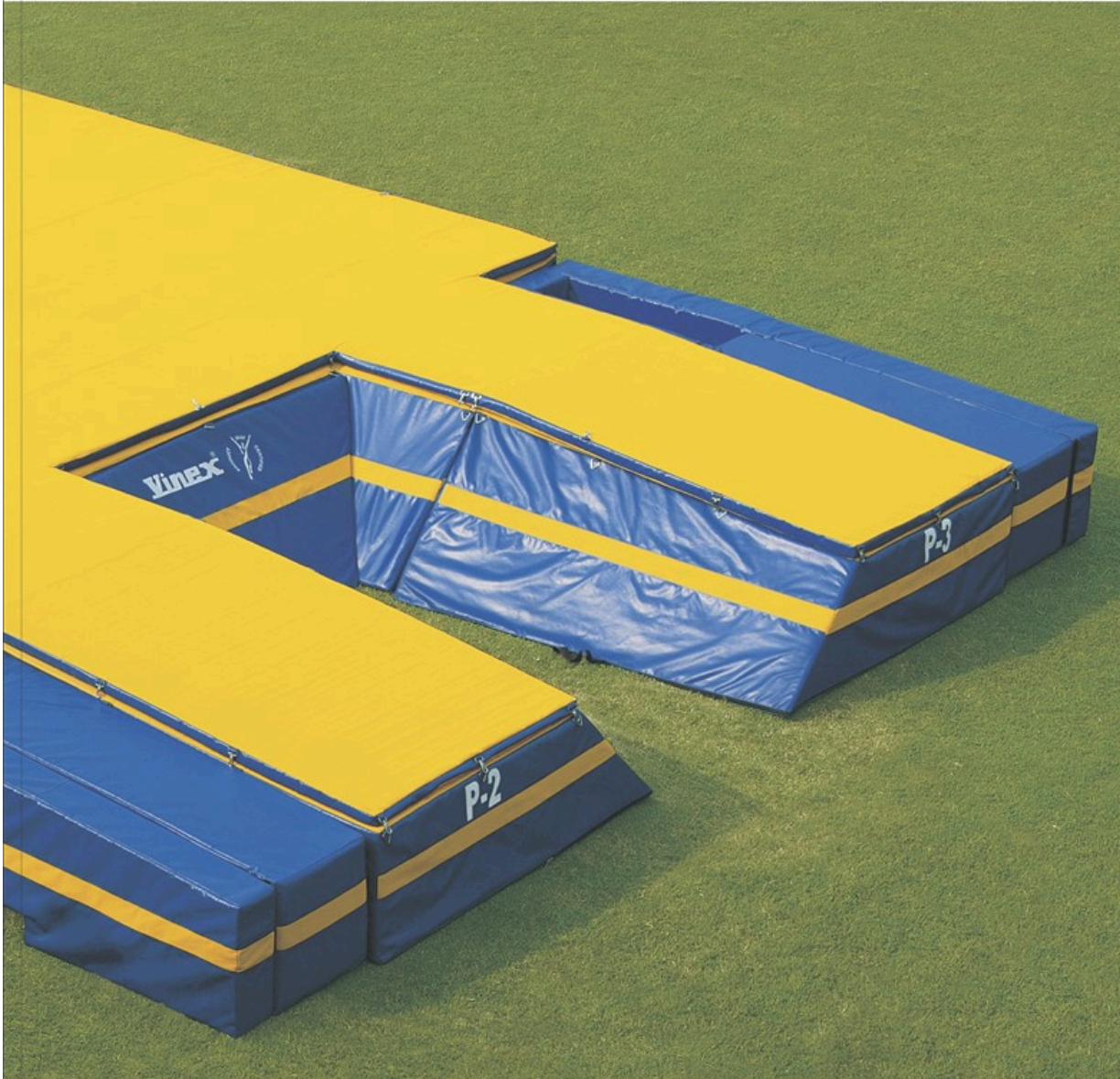

POLE VAULT PIT - RAIN COVER

VPVP-700RC (600 cm x 800 cm x 80 cm)

VPVP-702RC (680 cm x 500 cm x 80 cm)

Awarded No. 1 by SGEPC
for Highest Exports of Athletic Equipment from India



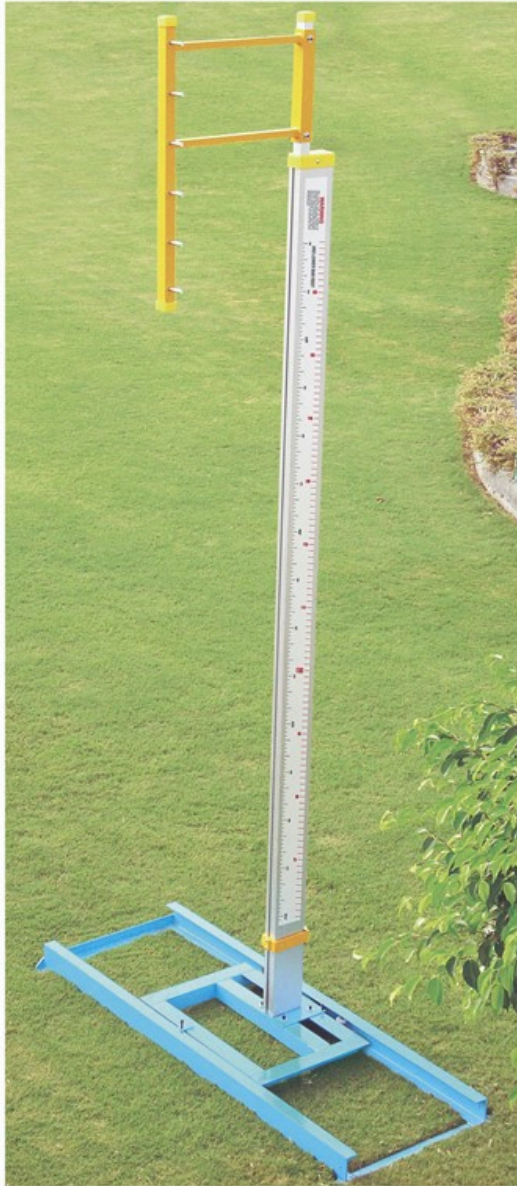

POLE VAULT STAND ALUMINIUM - COMPETITION

The uprights and risers are made of heavy gauge aluminium tubing. Height adjustment up to 21.75 feet, English and Metric Scale. Bases are made of heavy steel for extra sturdiness and stability. These bases are detachable for easy transportation and storage. Also includes 8 Anchor pins. **Height adjustment from 366 cm to 640 cm.**

PVS-CPTA



POLE VAULT STAND - COMPETITION

Made of heavy gauge steel pipe. Easy height adjustment. Upright detaches from base rail for easy storage and transportation. Extension arms for safety. **Height adjustment from 366 cm to 640 cm.**

PVS-CPT



POLE VAULT STAND - CLUB

Made of heavy gauge steel pipe. Easy height adjustment. Upright detaches for easy storage and transportation. Extension arms for safety. **Height adjustment from 366 cm to 640 cm.**

PVS-CLB





Kidz Athletics Kit[®]

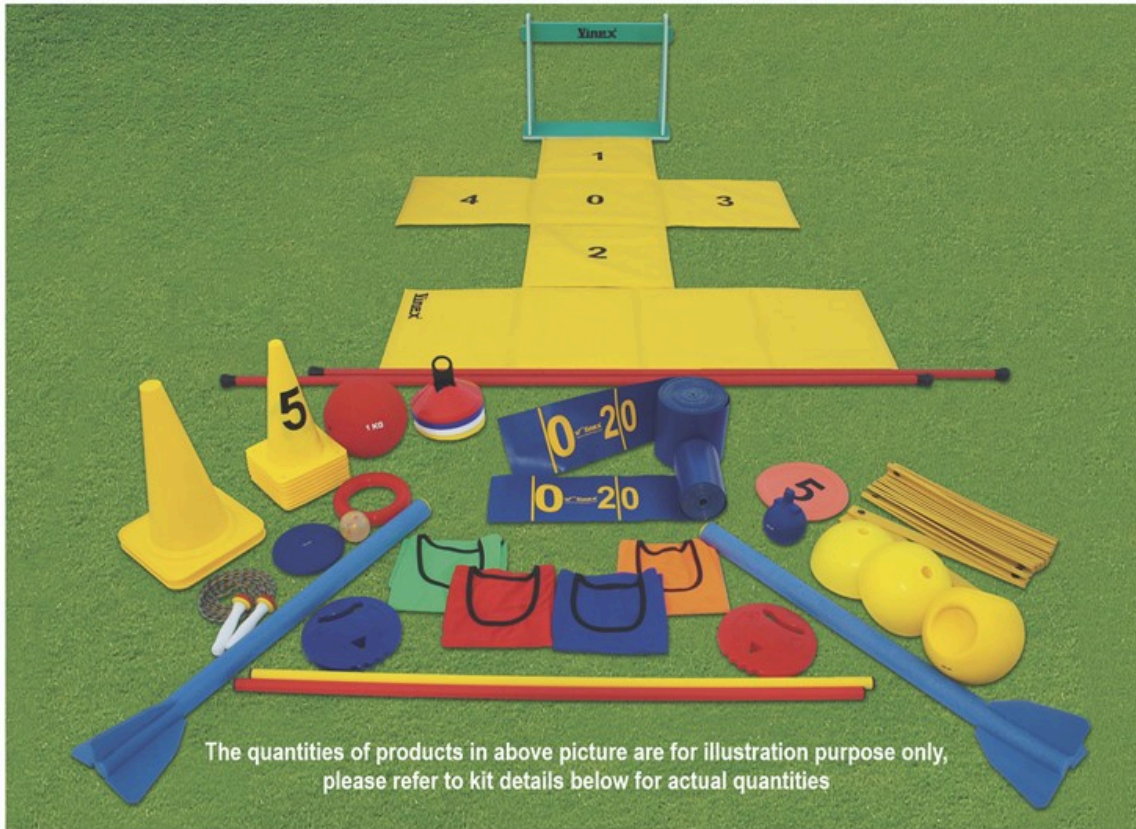

VINEX KIDZ ATHLETICS KIT - SUPERIA

Vinex is offering a special Kidz Athletic Kit that covers all the major training equipment required for practicing of different kinds of Athletic Sports. This kit is best for schools & clubs offering Athletic training to kids, which will help them in developing athletic sporting skills from a very early age.

The kit includes the following equipment:

- | | |
|--|---|
| 1 x Event Wall Hanging Banner (3 m x 1.4 m) | 2 x Medicine Ball Duraz (1 kg) |
| 1 x Multi Throw Discus (400 gm) | 1 x Elementary Discus (300 gm) |
| 16 x Soft Mesh Polyester Pinnies (Small size in 2 colors) TBN-801SF | 32 x Soft Mesh Polyester Pinnies (Medium size in 4 colors) TBN-802SF |
| 4 x 15" Cones | 14 x Plastic Dome Bases |
| 14 x Plastic Poles (120 cm x 25 mm) | 100 x PVC Rainbow Balls |
| 26 x PVC Fabric - Sports Event Stations | 1 x Elastic Stopper 4 m Long |
| 4 x Foldable 10 mm Thick Foam Mats (1.5 m x 0.6 m) | 14 x Adjustable Foam Hurdle (W: 70 cm & H: 30 cm to 50 cm) |
| 2 x Plastic Kettle Balls Soft (500 gm) | 1 x Cross Hop Mat |
| 2 x Elementary Foam Javelins | 1 x Measuring Scale - Roll (50 m Long) |
| 1 x Measuring Scale - Roll (20 m Long) | 6 x Floor Markers with numbers 0 to 5 (Total 6 pc) |
| 8 x 12" Cones with Numbers 5, 10, 15, 20, 25, 30, 35 & 40 | 1 x 9' Skipping Rope |
| 2 x Throwing Poles | 2 x Elementary Javelin Throw Ball (400 gm) |
| 40 x 2" Concave Cut Cones | 6 x PVC Rings with Rib |
| 1 x Anti-Skid Crisscross Ladder 9 m | 1 x Bag with Wheels to carry all above |

VKIDZ-ATSP Complete Kit

Awarded No. 1 by SGEPC
for Highest Exports of Athletic Equipment from India





VINEX JUNIOR FOAM HURDLE - PRIMA

Vinex new foam hurdle made of PE foam, specially designed considering the safety of kids. Light in weight and easy to assemble. Comes flat packed for economical storage & transportation. Has two heights - 30 cm & 50 cm.

VJFH-L70H30 Each pc
VJFH-L70H30PK6 Pack of 6 pc

VINEX PVC RING WITH RIB

New Deck tennis rings made of soft PVC, can be used for varied tossing and catching games.

VTR-S66 Each pc
VTR-S66PK6 Pack of 6 pc



VINEX MULTI-THROW DISCUS - SUPER

Multi-Throw discus is an ultimate device for multi-sports throw training like Shotput Throw, Hammer Throw & Discus throw. It is made of soft PVC. Available in assorted colours and weights.



VEHD-PVC400 400 gm Each pc
VEHD-PVC500 500 gm Each pc
VEHD-PVC600 600 gm Each pc
VEHD-PVC700 700 gm Each pc
VEHD-PVC800 800 gm Each pc

VINEX NUMBER SPOTS - SUPER

Rubber Spots with numbers printed from 0 to 5. Comes in assorted colours.

VRBS-S06 Set of 6 pc



VINEX NUMBER CONES - 12

12" Cones with Numbers printed 5, 10, 15, 20, 25, 30, 35 & 40. Available in Red, Blue, Green, Yellow and Orange colour.

VCM-12NCS Pack of 8 pc



VINEX ELASTIC CORD - CROSSBAR

Vinex Elastic Crossbar cord made of 5 mm thick elastic cord with burned ends and stopper. Length: 4 m loop

VEC-C04M Each pc



VINEX BUNGEE CORD - CLUB

New Bungee cord made of 5 mm thick elastic cord with burned ends & stopper.

VEBC-C23



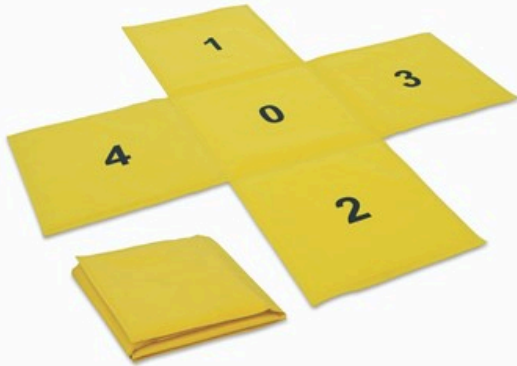

VINEX CROSS HOP MAT - FOLDING (SINGLE COLOUR)

Gym mats made of PVC coated fabric with 4 Cross folding panels & filled with 10mm PE foam. Printed with Numbers 0 - 4. Easy to fold for compact storage and economical transportation. **Size:** 1.5 m x 1.5 m x 10 mm

VCHM-FSC151510 Each pc



VINEX STRAIGHT MAT - FOLDING (SINGLE COLOUR)

Gym mats made of PVC coated fabric with 4 straight folding panels and filled with 10mm PE foam. Easy to fold for compact storage and economical transportation. **Size:** 1.5 m x 0.50 m x 10 mm

VSM-FSC15510

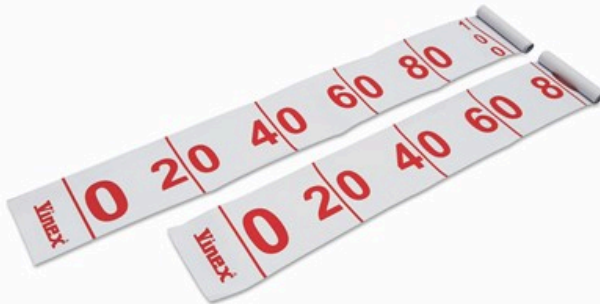

VINEX MEASURING ROLL - CLUB

Vinex Measuring Roll made of VINYL fabric with scale printed on the roll. Available in different lengths.

VMR-FLX20MW 20 m 1 pc
VMR-FLX50MW 50 m 1 pc



VINEX MEASURING ROLL - PVC

Measuring Roll made of PVC coated fabric with scale printed on the roll. Available in different lengths.

VMR-PVC20M 20 m 1 pc
VMR-PVC50M 50 m 1 pc



VINEX RAINBOW BALL - SUPER

New rainbow ball made of soft vinyl.

VRB-S70 70 gm

VINEX PLAY BALL

Vinex Play ball made of rubber with felt covering, durable and long lasting. Ball delivers excellent speed, bounce and consistent performance. Can be used for many fun play games.

VTB-065



VINEX VAULTING POLE- KIDZ

Vaulting pole for kids made of fiberglass for pole vault practice or leisure sports.

Length: 2 m
Diameter: 2.5 cm

VTP-KIDZ225S1 Each pc





ELEMENTARY SHOT

Made of soft PVC available in assorted colours.

- VES-400** 400 gm
- VES-500** 500 gm
- VES-600** 600 gm



ELEMENTARY DISCUS

Made of soft PVC available in assorted colours.

- VED-200** 200 gm **VED-500** 500 gm
- VED-350** 350 gm **VED-750** 750 gm



ELEMENTARY HAMMER

Made of soft PVC available in assorted colours.

- HEV-350** 350 gm
- HEV-400** 400 gm
- HEV-500** 500 gm

ELEMENTARY FOAM JAVELIN

Elementary Javelin made of foam tube. **Tube size** : 90 cm x 5 cm

VEJ-F905



ELEMENTARY FOAM JAVELIN - SOLID

Vinex Elementary Foam Javelin made of 50 mm solid tube. **Tube Size** : 95 cm x 5 cm

- ① **VEJ-F905SO** 1 pc
- VEJ-F905SOPK6** Pack of 6 pc

Vinex Elementary Foam Javelin made of 50 mm solid tube. **Tube Size** : 50 cm x 5 cm

- ② **VEJ-F50SO** 1 pc
- VEJ-F50SOPK6** Pack of 6 pc

Available in different colours, please ask for more details.



VINEX KIDS PLASTIC JAVELIN

Vinex Kids Plastic Javelin made of strong plastic. **Length**: 70 cm ; **Weight**: 300 Grams

VEJ-P70 1Pc

ELEMENTARY JAVELIN BALL

- JKB-200** 200 gm **JKB-600** 600 gm
- JKB-400** 400 gm **JKB-800** 800 gm



ELEMENTARY CARRYING BAG

These bags are made by using combination of Heavy Duty mesh fabric and nylon coated fabric.

- ① **HEV-B100** Carries 4 Elementary Hammers
- ② **VED-B100** Carries 4 Elementary Discus
- ③ **VES-B100** Carries 4 Elementary Shots





VINEX TRACK KERBING

Heavy gauge aluminium features a box profile top. Held in place by 10 mm tall ribbed feet. Raised 10 mm off the track surface for rapid drainage. Each section of kerbing is milled to allow easy drop in or removal of corresponding sections. Available in Raw or anodized finish.

VTK-100

Awarded No. 1 by SGEPC
for Highest Exports of Athletic Equipment from India





DISCUS AND HAMMER THROWING CAGE

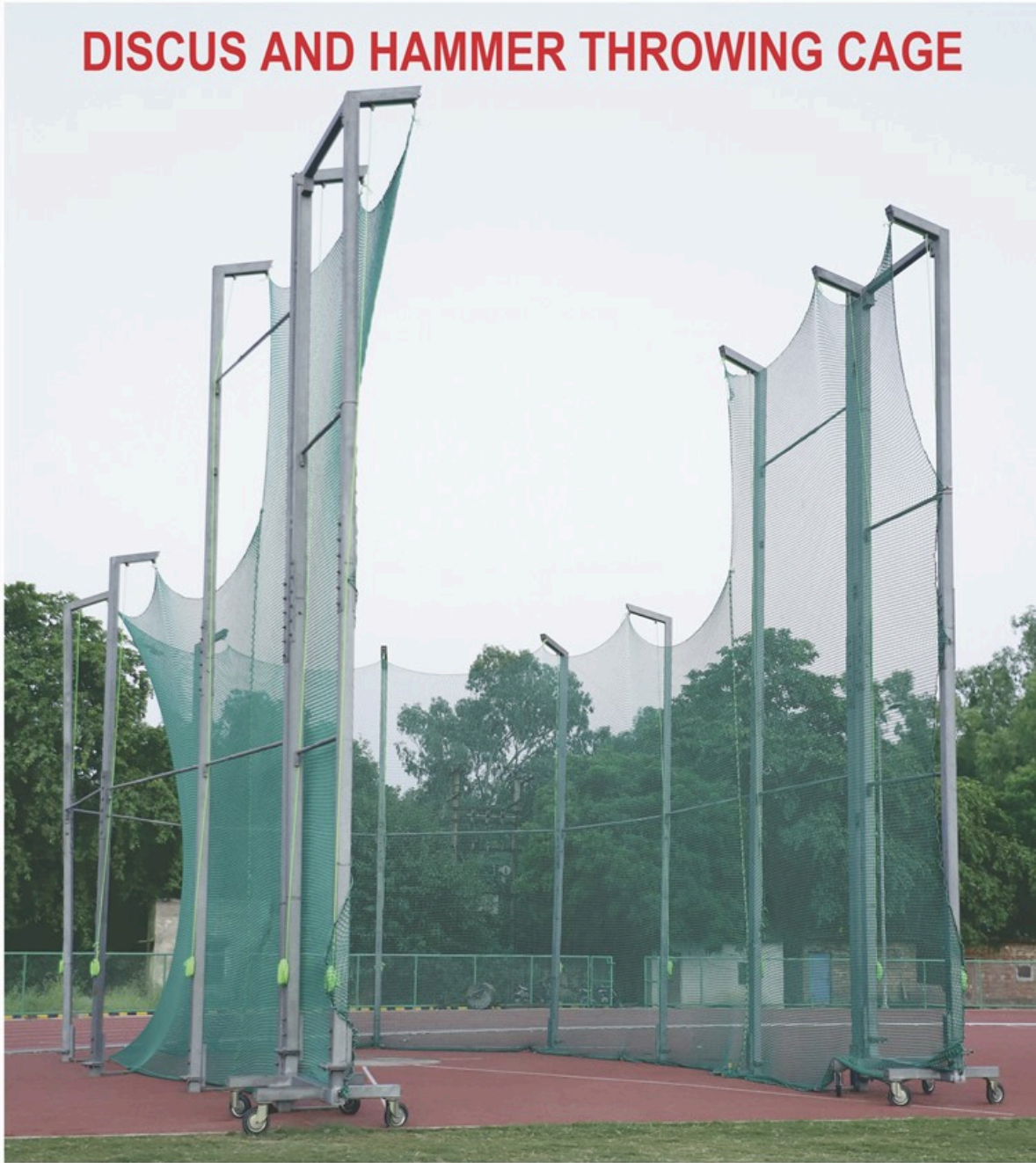

VINEX DISCUS AND HAMMER THROWING CAGE

Discus and Hammer throwing cage made of 113 mm square tube, HOT GALVANIZED for long life. Net is 5 mm thick with 40 mm knotless square mesh.

DHC-S101

Cage with netting.





DISCUS AND HAMMER THROWING CAGE



VINEX DISCUS AND HAMMER THROWING CAGE CHALLENGE

Made of heavy duty 100 mm Square Steel Tube, HOT GALVANIZED for long life. Poles can be detached from centre for easy transportation and hinged for easy lifting during installation. Easy to bind the poles together with the help of tie bars for sturdiness of the cage. Gates are attached to the poles using four hinges and both gates include wheels for easy movement. **NET** is 5 mm thick (machine knitted) with 40 mm square mesh. Net is UV stabilized for long life. Steel tube is used on the top of the net to avoid sagging.

DHC-S101C Cage with netting.
DHC-NOC Net only.





DISCUS THROWING CAGE



VINEX DISCUS THROWING CAGE

Made of heavy duty 92 mm Square Steel Tube, HOT GALVANIZED for long life. Poles can be detached from centre for easy transportation and hinged for easy lifting during installation. All poles are bound together with the help of tie bars for sturdiness of the cage. Machine knitted 5 mm thick net with square mesh of size 40 mm. Net is UV stabilized for long life. Steel tube is used on the top of the net to avoid sagging.

- DC-S101** Cage with netting.
- DC-NO** Net only.



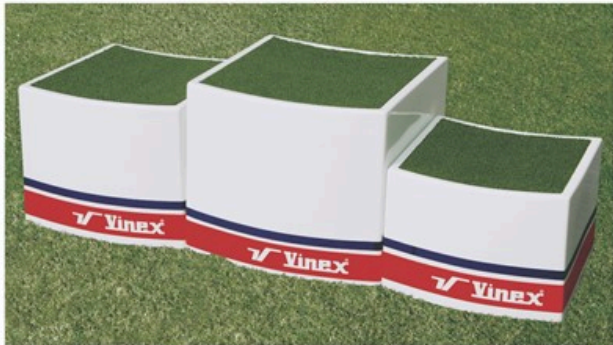

VINEX VICTORY STAND - COMPETITION

Vinex victory stand made of fibreglass, painted for durable finish. Top surface comes with artificial grass. Stands stacks inside one stand for easy storage and economical transportation.

VVS-C0123 Set of 3 pc (1, 2 & 3)



VINEX VICTORY STAND

Made of Aluminium, powder coated for extra durability. Fits telescopically in a box to reduce volume while packing. Bolted together for stability.

VVS-100



VINEX STARTER'S / ROSTRUM STAND

Made of Aluminium, powder coated for extra durability. Portable and light in weight.

VSS-100



FINISH POST

The post and the base are made of heavy duty steel. Features powder coated finish and in-built wheels make the movement of the post easier.

FPP-555 Sold in pair

Awarded No. 1 by SGEPC for Highest Exports of Athletic Equipment from India





VINEX POLE VAULT BOX - COMPETITION

Welded stainless steel construction. Comes with blanking board made of aluminium. Sockets at bottom for drainage of water.

PVT-SS1

POLE VAULT BOX - CLUB

As per IAAF specifications, made of steel with flared and tilted ends. Powder coated for durability.

PVT-S55



VINEX TAKE-OFF BOARD SYSTEM

Latest design take-off board system, made of solid wood. Welded aluminium tray protects take-off area and facilitates easy replacements of take-off board and plasticine board. Comes with heavy construction aluminium blanking lid for durability.

VSTB-100



VINEX FIBRE STOP BOARD - COMPETITION

Stop board made of fibre designed for depressed pad.

STB-F100





SHOT TOE BOARD WOODEN

① **STB-W100**

SHOT TOE BOARD ALUMINIUM

② **STB-A/100** For Depressed pad
IAAF CERTIFICATE # E-05-0415

③ **STB-A101** For Level pad

TAKE-OFF BOARD WOODEN

④ **TOB-W100**

SHOT TOE BOARD FIBERGLASS

Shot toe board made of fiberglass with detachable depressed pad. Size: 18 x 3.6 cm

STB-F200



VINEX PERFORMANCE INDICATOR

Frame made of steel. Upper row is meant for COMPETITOR / ATTEMPT and bottom row is for PERFORMANCE. Base and frame are powder coated for durable finish. Digit sizes are 8". Base with take-away wheels.

VPI-100



VINEX TENNIS COURT FLOOR ROLLER

Floor roller made of tough durable polyvinyl alcohol (PVA) foam. It quickly absorbs water from court. Sturdy frame made of aluminum to keep weight lighter & the handle can be dismantled using pushpin mechanism for easy storage and transportation.

VTCFR-S100



VINEX BRASS BELL

Replacement bell for a lap score board made of brass and it can be fixed to a vertical surface with help of a hanging hook.

VLS-BELL



LAP SCORING STAND

Frame is made of steel for extra stability with large and easy to read numbers. The base is made of heavy steel for stability on ground. Comes with bell.

VLS-20

Awarded No. 1 by SGEPC for Highest Exports of Athletic Equipment from India





VINEX CONVERSION CIRCLE

Vinex IAAF certified conversion circle made of Fibreglass sections with reinforced Steel. Sections are designed to quickly convert the already set Discus Circle to a Hammer Circle.

VCC-100 Each pc



VINEX SHOT / HAMMER THROWING CIRCLE - ALUMINIUM

Aluminium Shot /Hammer Circle made of heavy duty aluminium. This can be folded in 2 parts for easy transportation.

DSHC-SPA10



VINEX DISCUS THROWING CIRCLE - ALUMINIUM

Aluminium Discus Circle made of heavy duty aluminium. This can be folded in 2 parts for easy transportation.

DSHC-A100



DISCUS / SHOT - HAMMER CIRCLE

Made of steel as per IAAF specifications.

DSHC-S100 Shot-Hammer Circle 2.135 m

DSHC-SP100 Discus Circle 2.5 m





VINEX DISTANCE MARKERS

Made of moulded fibreglass, light-weight and compact stackable design to make packing and transportation easy. Triangular design provides visibility from all sides.

VDM-100 Height: 41cm
VLM-200 Height: 31cm

Printing on request.

VINEX DISTANCE MARKERS - SUPER

Made of Aluminium, compact stackable design to make packing & transportation easy. Larger printing for better visibility.

VDM-SA41 Height: 41 cm, Length: 33 cm
VDM-SA31 Height: 31 cm, Length: 33 cm

Printing on request.

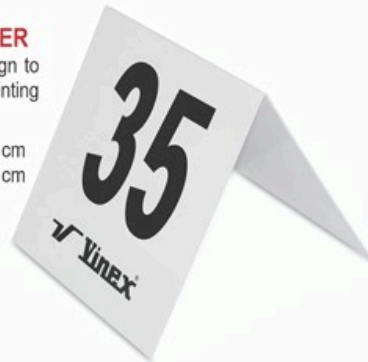

VINEX TAKE-OFF MARKER

Take-off marker for long and triple jump with black stripes on both sides. Made of aluminium & powder coated for durable finish.

VTOM-100

VINEX LONG JUMP DISTANCE INDICATOR MARKER

Long Jump and Triple Jump distance marker, made of Aluminium. Comes in set of 2 pc, total length 4 m (2 m length each marker). Please confirm the requirement of numerics to be printed on markers while placing your order.

VLJM-509 4.5 m to 8.5 m

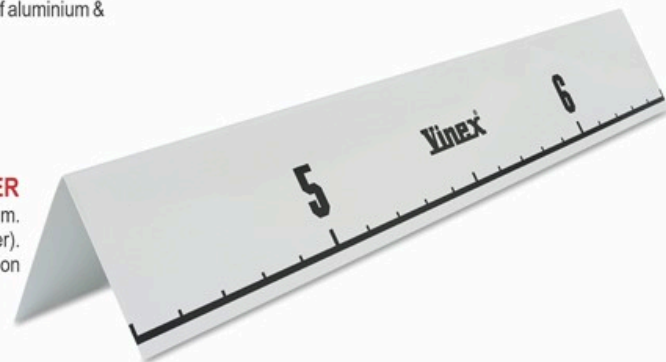

VINEX LANE MARKER - GRAND

Made of moulded fibreglass, light-weight and stackable design for easy packing & transportation. Triangular design provides visibility from all sides. False start indicator installed on top.

VLM-G100 Height 60 cm





MEASURING TAPE - OPEN REEL

Measuring Tape made of fibreglass open reel. Available in different lengths.

MST-OR30M	30 m
MST-OR50M	50 m
MST-OR100M	100 m



MEASURING TAPE STEEL - OPEN REEL

Measuring Tape made of STEEL open reel. Available in different lengths.

MST-ORS30M	30 m
MST-ORS50M	50 m
MST-ORS100M	100 m



MEASURING TAPE - CLOSED REEL

Measuring Tape made of fibreglass closed reel. Available in different lengths.

MST-CL10M	10 m	MST-CL30M	30 m
MST-CL20M	20 m	MST-CL50M	50 m



VINEX MEASURING TAPE STEEL - OPEN REEL PRO

Measuring tape made of STEEL open reel. Available in two lengths.

MST-ORP30	30 m	MST-ORP50	50 m
------------------	------	------------------	------



MEASURING TAPE STEEL - CLOSED REEL

Measuring Tape made of STEEL closed reel. Available in different lengths.

MST-CLS10M	10 m	MST-CLS30M	30 m
MST-CLS20M	20 m	MST-CLS50M	50 m



DISTANCE MEASURING WHEEL

Ideal for measuring large surfaces, external & internal spaces single handedly, including construction sites, paths, roads and fields. Mechanical 5 digit counter with quick reset lever. Comes with a carry bag. Measuring range up to 10 KM. (Least Count: 1 Meter).

DMW-CL100



VINEX MEASURING CANE STEEL

Measuring Cane made of 3 mm steel wire with ring on the top to carry. You attach any measuring tape held in place by screw near bottom of Cane without having to bend over.

VMCS-100

VINEX MEASURING TAPE - STAKES

Vinex measuring tape stake made of steel. The stake/cane attaches to the end of measuring tape on the ground and assists the judges in marking distances, positions on field, without having to bend down. Easy to hold & push to ground with its right angled handle with grip. It can be used for several events like throwing & jumping.

VTPS103	1 pc
VTPS103PK4	Set of 4 pc

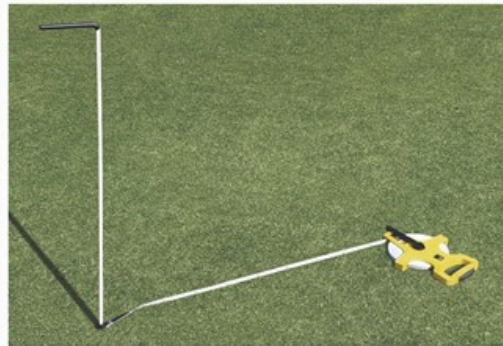



VINEX PORTABLE 6-SEATER FOLDING TEAM CHAIR

Vinex portable 6-Seater folding team chair made of steel frame and heavy duty fabric. Powder coated for extra durability. It's easy to use folding design can be set up in no time. Built-in backrest for added support and comfort.

Size : 2.65 m (L) x 52 cm (W) x 84 cm (H)

VRCH-6PFC

VINEX REFEREE CHAIR - CLUB

Vinex Club Referee Chair made of sturdy steel tube frame and durable polyester fabric. Powder coated for extra durability. Easy to close and fold for easy transportation & storage.

VRCH-CL01 1 pc



VINEX UMPIRE CHAIR

Umpire chair made of nickel plated tubular steel for extra strength & durability. Easy to transport and assemble. Height: 5'

VUC-TSC Chrome Plated
VUC-TSPC Powder Coated

UMPIRE STOOL

Stool is made of heavy duty tetron & tubular pipe. Foldable, easy for carrying & storage.

VUST-T100



VINEX STARTER CLAPPER

Starter clapper made of wood for the best sound with dual colour painted for visual starting signal.

VSCP-100

Awarded No. 1 by SGEPC
for Highest Exports of Athletic Equipment from India



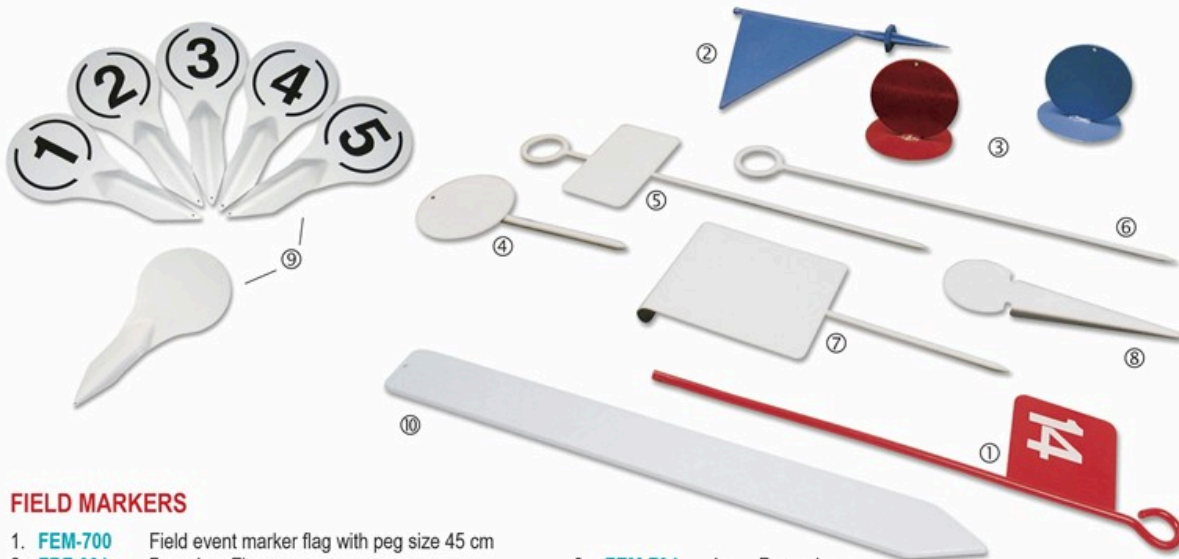

FIELD MARKERS

- | | | | |
|-------------------|--|--------------------|--|
| 1. FEM-700 | Field event marker flag with peg size 45 cm | 6. FEM-704 | Long Peg only |
| 2. FBF-001 | Boundary Flags | 7. FEM-705 | Rectangular folded metal sheet with long peg |
| 3. FEM-701 | Field Event Marker made of two fixed round metal sheet in assorted colours | 8. FEM-706 | Die punched special quality |
| 4. FEM-702 | Round metal sheet with small peg | 9. VRM-100 | Rink markers |
| 5. FEM-703 | Rectangular sheet with long peg | 10. WRD-100 | Dividers |
| | | | |
| | | | |

Different colour markers and printing available on request.



VINEX PENANT STREAMER - HOLDER

Made of 5 mm steel wire, powder coated. Used for field markings with pennant streamer or other flags.

- PSN-HS590** Single half spiral 90 cm height
- PSN-HS5150** Double half spiral 150 cm height



PENNANT STREAMERS

Pennants made of nylon cloth 12" long, available in assorted colours. Total length 100'.

PSN-100



COMPETITION PAPER NOS.

- | | |
|------------------------|-------------------------|
| CPN-001 1-100 | CPN-501 501-600 |
| CPN-101 101-200 | CPN-601 601-700 |
| CPN-201 201-300 | CPN-701 701-800 |
| CPN-301 301-400 | CPN-801 801-900 |
| CPN-401 401-500 | CPN-901 901-1000 |

FIELD MARKER CARRIER

A comfortable field marker carrier made of 4 mm steel wire, PVC coated for extra durability. This cart can carry upto 20 Long peg field markers at a time, making it a very practical field marker carrier.

Marker not included.

VFMC-705S



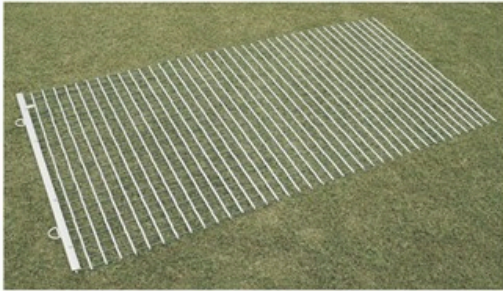

VINEX DRAG MAT

Vinex Drag Mat made of corrosion resistant galvanized steel. Heavy duty metal angles across front of mat for pulling with help of 16 mm polypropylene rope to smooth out uneven surface. Mesh size is 1.5" x 1.5". Available in different sizes.

- VDM-ST62** 6' (W) x 2' (L) **VDM-ST43** 4' (W) x 3' (L)
- VDM-ST63** 6' (W) x 3' (L) **VDM-ST42** 4' (W) x 2' (L)
- VDM-ST64** 6' (W) x 4' (L)

Chain version is also available on request.



SHOT CARRIER

Made of strong PP braided cord to carry one shot

VSC-100



VINEX DISCUS CARRYING BAG - SUPER

Discus bag made of Heavy Duty polyester fabric with two open inner compartments to carry 2 Discus. Comes with adjustable shoulder strap.

VDCB-S100

Please confirm colour before ordering. Customized sizes are also available on request, please ask for more details.



DISCUS BAG

Made of strong cloth with Velcro. Ideal for promotional purposes.

VDB-100

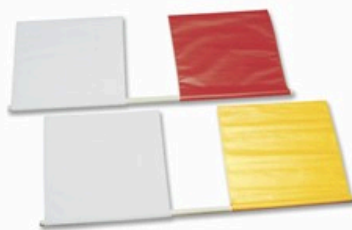

OFFICIAL FLAGS

Flag 16" x 16" made of thick tetron cloth, visible from long distance, attached to plastic pipe.

- VOF-111** Red / White
- VOF-112** Yellow / White



OFFICIAL FLAGS - SUPER

Single colour flag, 38 cm x 41 cm, made of polyester fabric. Tube made of **SEP (plastic)**, 50 cm long with hand grip, it features Swivel function

VOF-SU50

* Customized tube lengths also available on request



OFFICIAL FLAGS - CLUB

Single colour flag, 41 cm x 41 cm, made of heavy duty polyester fabric. Tube made of **SEP (Plastic)**, 54 cm long and without hand grip. It features swivel function.

VOF-CL54

* Customized tube lengths also available on request





VINEX SHOT CART - DURA

Fixed cart, made of heavy duty steel pipe. Suitable for 10 Shots. Comes with extra durable wheels.

DSC-DU10



VINEX DISCUS CART - DURA

Fixed cart, made of heavy duty steel pipe. Suitable for 30 discus. Comes with extra durable wheels.

DISC-DU30



VINEX HAMMER CART - DURA

Fixed cart, made of heavy duty steel pipe. Suitable for 10 Hammers. Comes with extra durable wheels.

DHC-DU10





VINEX DISCUS / SHOT / JAVELIN CART - DURA

Fixed cart, made of heavy duty steel pipe. Suitable for 6 Javelins, 4 Shots, 4 Hammers and 4 Discus. Comes with extra durable wheels.

DSJC-DU



VINEX JAVELIN CART - DURA

Fixed cart, made of heavy duty steel pipe. Suitable for 20 javelins. Comes with extra durable wheels.

JAL-DU20



VINEX HURDLE CART - DURA

Made of heavy duty steel pipe, with larger diameter wheels for easy transportation. It comes in 2 variants to carry 20 Hurdles. Features 2 x Revolving and 2 x fixed wheels. Foldable design to reduce storage and transportation cost.

VSHC-DU20PC
VSHC-DU20HG

Powder coated
Hot galvanized

VINEX STARTING BLOCK CART - DURA

This newly design starting block can conveniently carry 10 Starting Block sets. It is made of heavy duty steel tube, with large front branding fascia made of steel and bottom made of heavy steel mesh for holding the blocks. Features Large wheels for easy movement on rough and coarse ground with 2 x 360 degrees revolving wheels.

VSB-CP10





JAVELIN CART

Made of heavy steel tube. Suitable for 30 Javelins. Comes with extra durable swivel wheels. Foldable to reduce freight cost.

JAL-C30



DISCUS / SHOT / JAVELIN CART

Made of heavy steel pipe. Suitable for 12 Javelins, 12 Shots and 30 Discus. Comes with extra durable swivel wheels. Foldable to reduce freight cost.

DSJC-100



DISCUS / SHOT CART

Made of heavy steel pipe. Suitable for 12 Shots and 30 Discus. Comes with extra durable swivel wheels. Foldable to reduce freight cost.

DSC-S25



VINEX HAMMER CART / STAND

Made of heavy steel tube. Suitable for carrying 18 Hammers. Comes with extra durable swivel wheels. Foldable to reduce freight cost.

VHC-S18





HURDLE CART - SUPERB

Cart is made of steel, with larger diameter (20 cm) wheels for easy transportation. Powder coated for durability and comes in 2 variants to carry 10 and 20 Hurdles. Features 2 x Revolving wheels and 2 x Fixed wheels.

- VSH-SC10 For 10 Hurdles
- VSH-SC20 For 20 Hurdles

HURDLE CART

Cart is made of steel and can easily carry 10 hurdles. Features powder coating, Heavy Duty wheels with locking device.

VSH-C10



STARTING BLOCK CART

Cart is made of steel and can easily carry 10 starting blocks. Features powder coating, Heavy Duty wheels with locking device.

VSB-C10

VINEX HURDLE CART - PRO

Vinex Collapsible Hurdle PRO-Cart, made of heavy duty steel, that can carry up to 20 - 30 Hurdles. Black powder coated for durability. Features 4 Large wheels with 2 x 360 Degree revolving wheels with lock.

VSH999-CLC20





VINEX CANOPY

Easy up canopy made of aluminium frame and heavy duty polyester fabric. Easy to fold & store. **Size** : 3 m x 3 m

- VCAN-3X3M** Without bag
- VCAN-3X3MWB** With bag

Customised sizes are also available on request.



VINEX CANOPY - SUPER

Easy up canopy made of aluminium frame and heavy duty polyester fabric. Easy to fold & store. **Size** : 2 m x 2 m

- VCAN-2X2M** Without bag
- VCAN-2X2MWB** With bag

Customised sizes are also available on request.



VINEX TEAM SHELTER SUPER

8 seater, Heavy Duty mobile team shelter made of steel equipped with plastic moulded seats. High quality transparent polycarbonate roof. Seat height 45 cm from ground level.

Shelter size : 2.0m (L) x 1.01m (D) x 1.75m (H)

VTSH-S100



VINEX TEAM SHELTER - CLASSIC

Made of Aluminium sheet and rectangular tubes. Shelter made of transparent Polycarbonate sheet and sitting bench made of wood.

Shelter size : 4.80m (L) x 0.80m (D) x 2.25m (H)

Seating Size : 4.80m (L) x 0.46m (D) x 0.52m (H)

VTSH-CL100

* It can also be customized as per requirement. Please ask for more details.





PRODUCT NAME	PAGE #	CE			REACH	CPSIA	LEAD PASS	PHTHALATES	ASTM
		PART - I	PART - II	PART - III					
Rubber Discus With Strap	18			✓	✓	✓	✓	✓	✓
Vinex Indoor Discus	18			✓	✓	✓	✓	✓	✓
Vinex Rubber Black Discus	18			✓	✓	✓	✓	✓	✓
Vinex Rubber Black - Coloured Center Discus	18			✓	✓	✓	✓	✓	✓
Vinex Rubber Indoor Brown Discus	18			✓	✓	✓	✓	✓	✓
Vinex Rubber Indoor Colour Discus	18			✓	✓	✓	✓	✓	✓
Vinex Rubber Indoor White Discus	18			✓	✓	✓	✓	✓	✓
Vinex Super Shot	19					✓			
Vinex Economy Shot	20			✓	✓	✓	✓		
Vinex Turned Economy Shot	20					✓			
Indoor Shot PVC Non Bouncy With Plug	21			✓	✓	✓	✓	✓	✓
Indoor Shot PVC Non Bouncy Without Rib	21			✓	✓	✓	✓	✓	✓
Indoor Shot PVC Solid With Rib	21			✓	✓	✓	✓	✓	✓
Indoor Shot PVC Solid Without Rib	21			✓	✓	✓	✓	✓	✓
Vinex Economy Unturned Cast Iron Hammer	22					✓			
Vinex Hammer Gloves Leather	22					✓			
Vinex Rubber Starting Block	27			✓	✓	✓	✓	✓	✓
Vinex Gold-100 (Relay Baton)	28			✓					
Vinex Relay Baton Aluminium - Powder Coated	28			✓					
Vinex Super-200 (Relay baton)	28			✓	✓				✓
Crossbar Rope	44					✓			
Elementary Shot	54	✓	✓	✓	✓	✓	✓	✓	✓
Elementary Discus	54	✓	✓	✓	✓			✓	
Elementary Hammer	54	✓	✓	✓	✓	✓	✓	✓	✓
Elementary Javelin Ball	54	✓	✓	✓	✓	✓	✓	✓	✓

